

| <b>Contents</b>   | <b>Page</b>       |
|---|-------------------|
| Standards . . . . .                                     | 1                 |
| General Information . . . . .                           | 2-3               |
| Electrical Characteristics/<br>Technical Data . . . . . | 4-9               |
| Electronic Trip Units . . . . .                         | 10-12             |
| Catalogue Numbers/<br>Termination Accessories           |                   |
| G-Frame,<br>16-100 Amperes . . . . .                    | 13                |
| E-Frame,<br>16-225 Amperes . . . . .                    | 14-15             |
| J-Frame,<br>100-250 Amperes . . . . .                   | 16-17             |
| K-Frame,<br>63-400 Amperes . . . . .                    | 18-19             |
| L-Frame,<br>315-800 Amperes . . . . .                   | 20-21             |
| N-Frame,<br>400-1250 Amperes . . . . .                  | 22-25             |
| R-Frame,<br>800-2500 Amperes . . . . .                  | 26-29             |
| Motor Circuit Protectors . . . . .                      | 30                |
| Frame Sizes G through R . . . . .                       | 31-32             |
| Handle Mechanisms . . . . .                             | 33-35             |
| Accessories and<br>Modifications . . . . .              | 36-38             |
| Time-Current Curves . . . . .                           | 39-40             |
| Current Limiting Curves . . . . .                       | 41                |
| Dimensions . . . . .                                    | 42-43             |
| Sales Offices . . . . .                                 | 44                |
| Typical<br>Specifications . . . . .                     | Inside Back Cover |

**Standards**

Cutler-Hammer Moulded Case Circuit Breakers are designed to conform with the following international standards:

- Australian Standard AS 2184 and AS 3947-2 Moulded Case Circuit Breakers.
- British Standards Institution Standard BS 4752: Part 1, Switchgear and Control Gear Part 1, Circuit Breakers.
- International Electrotechnical Commission Recommendations IEC 60947.2 Circuit Breakers. 
- Japanese T-Mark Standard Moulded Case Circuit Breakers.
- National Electrical Manufacturers Association Standards Publication No. AB1-1975 Moulded Case Circuit Breakers.
- South African Bureau of Standards, Standard SABS 156, Standard Specification for Moulded Case Circuit Breakers.
- Swiss Electro-Technical Association Standard SEV 947.2, Safety Regulations for Circuit Breakers.
- Union Technique de l'Electricite Standard NF C 63-120, Low Voltage Switchgear and Control Gear Circuit Breaker Requirements.
- Verband Deutscher Elektrotechnike (Association of German Electrical Engineers) Standard VDE 0660, Low Voltage Switchgear and Control Gear, Circuit Breakers.

**Global Third Party Certification**

Certification marks assure product compliance with the total standard via the third party witnessing of tests by globally recognized independent certification organizations.

KEMA is a highly recognized, completely independent international organization that offers certification and inspection facilities for equipment in many industries. The KEMA-KEUR mark is the highest certification an electrical product can receive from KEMA. Our IEC 60947-2 Moulded Case Circuit Breakers are KEMA tested and certified.

What does the KEMA-KEUR rating mean for you? It means an independent testing house. KEMA Registered Quality has tested and certified these products to IEC 60947-2 standards. In addition, KEMA is conducting ongoing follow-up witness test programs to assure IEC 60947-2 compliance to maintain the KEMA Certification mark, KEMA-KEUR has been a well-known and highly respected independent mark for over 70 years, a symbol of quality assurance that enjoys the confidence of both manufacturers and consumers.

Cutler-Hammer also offers a complete line of Moulded Case Circuit Breakers, UL listed in accordance with UL 489 as well as CSA C22.2 No. 5.1 certified are also available. Both UL and CSA are independent third party testing houses that continue to assure that Cutler-Hammer Moulded Case Circuit Breakers meet their exacting standards through regularly scheduled follow-up testing and inspections.

## Cutler-Hammer Frame Sizes G through R

### General Information

Cutler-Hammer Moulded Case Circuit Breakers provide increased performance in considerably less space than standard circuit breakers or comparable fusible devices. Reduced system costs can also be realized because Cutler-Hammer Circuit Breakers are used in series rated systems, allowing the use of lower interrupting circuit breakers downstream.

Cutler-Hammer Circuit Breakers meet applicable IEC 60947-2 standards, have been assigned ultimate and service interrupting ratings per IEC 60947-2, and employ adjustable thermal and adjustable magnetic trips.

The Cutler-Hammer family includes seven frame sizes in ratings from 100 to 2500 amperes. Each frame size offers a choice of several interrupting capacities up to 100 kA at 415 volts ac (200 kA at 240 volts ac). This provides greater design flexibility than ever before possible while also helping to save space.

Cutler-Hammer Circuit Breakers virtually eliminate the need for redesign and they can be used to replace older circuit breakers in the same panelboards, feeder pillars, busbar trunking tap-offs, individual enclosures, machine tool control panels, and motor control centres. In most cases, the same connecting straps, studs, and handle mechanisms can be retained and used.

Standard calibration is 40°C. For applications in high ambient temperature conditions, 50°C factory calibration is available.

Cutler-Hammer Circuit Breakers are also provided for dc applications. Interrupting ratings of 35 kA for the 600 ampere frame have been achieved for three-pole breakers in series at 600 volts dc.

### The Most Logically Designed Contact Assembly

The flexibility and outstanding performance characteristics of Cutler-Hammer Circuit Breakers are made possible by one of the most logically designed contact assemblies in circuit breaker history. Based on previously patented Westinghouse contact conductor designs, the Cutler-Hammer contact assembly creates a high-speed "blow-open" action when it confronts the electromechanical forces produced by high-level fault currents.

Cutler-Hammer Circuit Breakers are operated by a toggle-type handle that is mechanically trip-free from the handle so that the contacts cannot be held closed against short circuit currents. Tripping due to overload or short circuits is clearly indicated by the position on the handle. This remarkably fast and dependable contact action is designed to enhance safety.

### Thorough In-Plant Testing

The quality, dependability, and reliability of every Cutler-Hammer Circuit Breaker is assured by a thorough program of in-plant testing. Two calibration tests are conducted on every pole of every circuit breaker to verify the trip mechanism, operating mechanism, continuity, and accuracy.

### ISO Certification

Cutler-Hammer Circuit Breakers are manufactured in ISO certified facilities.

### More Interrupting Capacity in Less Space

Cutler-Hammer Circuit Breakers are physically and electrically interchangeable with the "Classic" standard line of Westinghouse moulded case circuit breakers. This means Cutler-Hammer Breakers are ideal for upgrading equipment designs and retrofitting existing installations.

### Current Limiting Characteristics

All Cutler-Hammer Circuit Breakers are current limiting because of their high repulsion contact arrangement and incorporation of state-of-the-art arc extinguishing technology.

### Operating Mechanisms

Cutler-Hammer Circuit Breakers have, in their basic version, a toggle handle operating mechanism, which also serves as switching position indicator. As well as ON and OFF, the further position TRIPPED is possible.

The toggle handle snaps into the TRIPPED position if the breaker is tripped by one of its overcurrent, short circuit, shunt or undervoltage releases. Before the circuit breaker can be reclosed following a trip-out, the toggle handle must be brought beyond the OFF position (RESET). The circuit breaker can then be reclosed.

As an additional switching position indicator for F- to R-Frame circuit breakers, there are two windows on the right and on the left of the toggle handle, in which the switching state is indicated by means of the colours red, green and white corresponding to the ON, OFF and TRIPPED positions respectively.

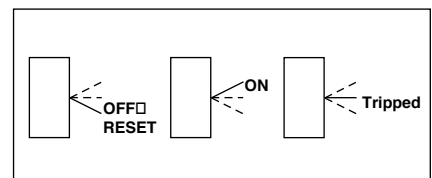

Positions of the Toggle Handle Drive

### Cutler-Hammer Frame Sizes G through R

#### Panelboards

As both main and branch circuit protection devices (G-, E-, J-, K-, L- and N-Frames).

#### Feeder Pillars

In distribution systems to provide main and branch circuit protection (E-, J-, K-, L-, N- and R-Frames).

#### Switchgear

In distribution systems to provide main and branch circuit protection up to 2500 amperes (R-Frame).

#### Busbar Trunking Tap-Offs

In busbar trunking tap-offs to provide branch circuit protection (F-Frame); and to provide feeder or branch circuit protection (J-, K- and L-Frames).

#### Individual Enclosures

Completely assembled in enclosures to meet specific customer requirements (G-, E-, J-, K-, L-, N- and R-Frames).

#### Machine Tool Control Panels and Motor Control Centres

Applied for specific equipment requirements (G-, E-, J-, K-, and L-Frames).

#### Additional Applications

Special versions of each Cutler-Hammer frame are available to provide safe equipment control and protection in mining and other applications. Contact your Cutler-Hammer agent or distributor for additional information.

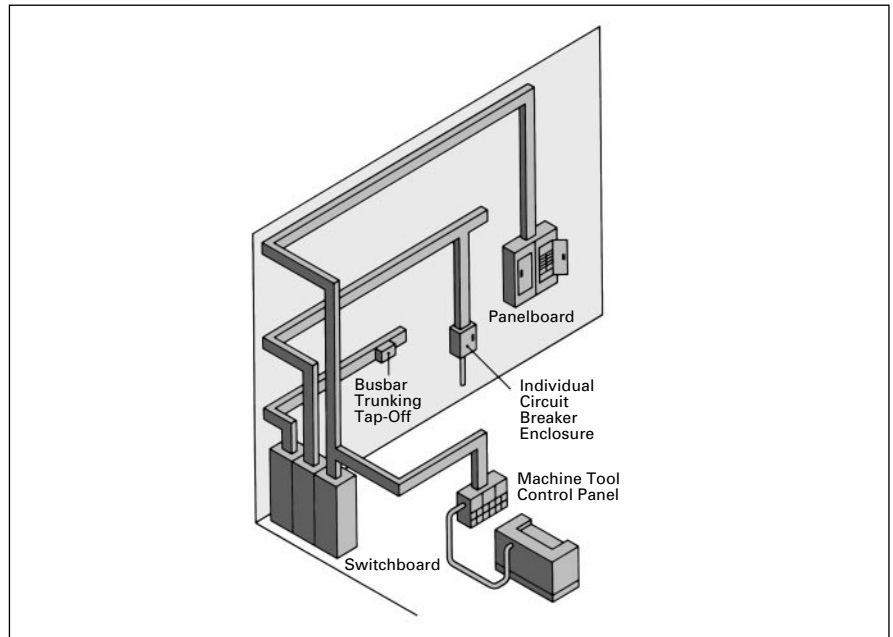





Typical Cutler-Hammer Applications

| Frame | Continuous Ampere Rating Range | Type of Trip Unit                 |                              |  |   |                                    | Moulded Case Switch |
|-------|--------------------------------|-----------------------------------|------------------------------|--|---|------------------------------------|---------------------|
|       |                                | Adjustable Thermal Fixed Magnetic | Fixed Thermal Fixed Magnetic | Adjustable Thermal Adjustable Magnetic | Adjustable Thermal Fixed Magnetic Earth Leakage | Digitrip RMS Electronic Trip Units |                     |
| G     | 16-100                         | –                                 | ■                            | –                                      | –   | –                                  | ■                   |
| E     | 16-125                         | ■                                 | ■                            | –                                      | –   | –                                  | ■                   |
| J     | 125-250                        | –                                 | –                            | ■                                      | ■   | –                                  | ■                   |
| K     | 63-400                         | –                                 | –                            | ■                                      | ■   | ■                                  | ■                   |
| L     | 315-800                        | –                                 | –                            | ■                                      | –   | ■                                  | ■                   |
| N     | 400-1250                       | –                                 | –                            | –                                      | –   | ■                                  | ■                   |
| R     | 800-2500                       | –                                 | –                            | –                                      | –   | ■                                  | ■                   |

## Cutler-Hammer Frame Sizes G through J

## Electrical Characteristics

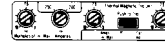
|  |                      | G   |        |                  | E   |         |        |         |        |         | J  |     |     |     |
|--|----------------------|---|--------|------------------|---|---------|--------|---------|--------|---------|--|-----|-----|-----|
|  |                      |  |        |                  |  |         |        |         |        |         |   |     |     |     |
| <b>Maximum Rated Current (Amperes)</b>       |                      | 100   |        |                  | 125   |         |        |         |        |         | 250  |     |     |     |
| <b>Breaker Type</b>                          |                      | GWF <sup>②</sup>  |        | GWF <sup>②</sup> | B   | E       | S      | H       | E      | S       | H  |     |     |     |
| <b>Breaker Capacity (kA rms) AC 50-60 Hz</b> |                      |   |        |                  |   |         |        |         |        |         |  |     |     |     |
| IEC 60947-2                                  | 220-240 VAC          | $I_{CU}$  | 18     | 65               | 25  | 25      | 35     | 85      | 85     | 100     | 100  | 65  | 85  | 100 |
|  |                      | $I_{CS}$  | 9      | 33               | 25  | 25      | 35     | 43      | 43     | 50      | 50   | 65  | 85  | 100 |
|  | 380-415 VAC          | $I_{CU}$  | —      | 25               | —   | 18      | 25     | —       | 40     | —       | 70   | 25  | 40  | 70  |
|  |                      | $I_{CS}$  | —      | 13               | —   | 18      | 25     | —       | 30     | —       | 35   | 25  | 40  | 70  |
|  | 660-690 VAC          | $I_{CU}$  | —      | —                | —   | —       | —      | —       | —      | —       | —  | 12  | 12  | 14  |
|  |                      | $I_{CS}$  | —      | —                | —   | —       | —      | —       | —      | —       | —  | 6   | 6   | 7   |
|  | 250 VDC <sup>③</sup> | $I_{CU}$  | —      | 10               | 10  | 10      | 10     | 35      | 35     | 42      | 42   | 10  | 22  | 22  |
|  |                      | $I_{CS}$  | —      | 5                | 10  | 10      | 10     | 35      | 35     | 42      | 42   | 10  | 22  | 22  |
| NEMA   | 240 VAC              | 18  | 65     | 25               | 25  | 35      | 85     | 85      | 100    | 100     | 65   | 85  | 100 |     |
|  | 480 VAC              | —   | 22     | —                | 18  | 25      | —      | 35      | —      | 65      | 25   | 35  | 65  |     |
|  | 600 VAC              | —   | —      | —                | —   | —       | —      | —       | —      | —       | 18   | 25  | 35  |     |
| <b>Number of Poles</b>                       |                      | 1   | 2, 3   | 1                | 2, 3, 4   | 2, 3, 4 | 1      | 2, 3, 4 | 1      | 2, 3, 4 | 2, 3, 4  |     |     |     |
| <b>Ampere Range</b>                          |                      | 16-125A   |        |                  | 16-125A   |         |        |         |        |         | 63-250A  |     |     |     |
| <b>Trip Units</b>                            |                      |   |        |                  |   |         |        |         |        |         | <br><b>Adjustable Thermal Magnetic</b><br><br><b>Adjustable Thermal Magnetic</b> |     |     |     |
|  |                      | Interchangeable   | —      |                  |   | —       |        |         |        |         |  | ■   |     |     |
|  |                      | Built-in  | ■      |                  |   | ■       |        |         |        |         |  | ■   |     |     |
| Thermal Magnetic                             | Fixed Thermal        | ■   |        |                  | ■   |         |        |         |        |         | ■  |     |     |     |
|  | Adjustable Thermal   | Fixed   |        |                  | ■   |         |        |         |        |         | ■  |     |     |     |
|  | Magnetic             | Fixed   |        |                  | Fixed   |         |        |         |        |         | Adjustable   |     |     |     |
| Solid State rms <sup>③</sup>                 | LS                   | —   |        |                  | —   |         |        |         |        |         | —  |     |     |     |
|  | LSI                  | —   |        |                  | —   |         |        |         |        |         | —  |     |     |     |
|  | LSG                  | —   |        |                  | —   |         |        |         |        |         | —  |     |     |     |
|  | LSIG                 | —   |        |                  | —   |         |        |         |        |         | —  |     |     |     |
| <b>Dimensions (mm)</b>                       | 1-Pole               | H   | 123.8  | 254.4            | 66.7  | 139.7   | W      | 25.4    | 76     | 177.8   | 105  | 103 |     |     |
|  |                      | 2-Pole  | 50.8   | 50.8             |   |         |        |         |        |         |  |     |     |     |
|  |                      | 3-Pole  | 76.2   | 76.2             |   |         |        |         |        |         |  |     |     |     |
|  |                      | 4-Pole  | —      | 101.6            |   |         |        |         |        |         |  |     |     |     |
|  | 4-Pole               | —   | —      | —                | —   | —       | —      | —       | —      | —       | 140  | —   |     |     |
| <b>Weight (approximate) Kgs.</b>             |                      | 1-Pole  | 2-Pole | 3-Pole           | 1-Pole  | 2-Pole  | 3-Pole | 4-Pole  | 2-Pole | 3-Pole  | 4-Pole   |     |     |     |
|  |                      | 0.4   | 0.7    | 1                | 0.45  | 0.91    | 1.36   | 1.81    | 5.2    | 5.2     | 7.0  |     |     |     |



① 2 poles in series.

② Not KEMA-KEUR listed. R-frame scheduled for 2001.

③ Not suitable for DC application. 4-pole ground fault not available.

Cutler-Hammer Frame Sizes K through L

Electrical Characteristics

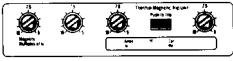
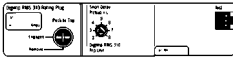
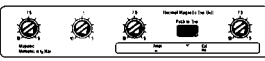
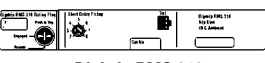
|  |                    | K   |     |                  |                          | L   |                  |                         |    |
|--|--------------------|---|-----|------------------|--------------------------|---|------------------|-------------------------|----|
|  |                    |    |     |                  |                          |    |                  |                         |    |
| Maximum Rated Current (Amperes)              |                    | 400   |     |                  |                          | 630   |                  |                         |    |
| Breaker Type                                 |                    | KW  | HKW | KWC <sup>①</sup> | LW                       | HLW   | LWC <sup>①</sup> | LW                      |    |
| <b>Breaker Capacity (kA rms) AC 50-60 Hz</b> |                    |   |     |                  |                          |   |                  |                         |    |
| IEC 947-2                                    | 220-240 VAC        | I <sub>CU</sub>   | 85  | 100              | 200                      | 85  | 100              | 200                     | 65 |
|  |                    | I <sub>CS</sub>   | 85  | 100              | 150                      | 85  | 100              | 150                     | 33 |
|  | 380-415 VAC        | I <sub>CU</sub>   | 45  | 70               | 100                      | 45  | 70               | 100                     | 50 |
|  |                    | I <sub>CS</sub>   | 45  | 70               | 75                       | 45  | 70               | 75                      | 25 |
|  | 660-690 VAC        | I <sub>CU</sub>   | 20  | 25               | 35                       | 20  | 25               | 35                      | 20 |
|  |                    | I <sub>CS</sub>   | 10  | 13               | 18                       | 10  | 13               | 18                      | 10 |
| 250 VDC <sup>②</sup>                         | I <sub>CU</sub>    | 10  | 20  | 20               | 20                       | 20  | 20               | 20                      |    |
|  | I <sub>CS</sub>    | 5   | 10  | 10               | 10                       | 10  | 10               | 10                      |    |
| NEMA   | 240 VAC            | 65  | 100 | 200              | 65                       | 100   | 200              | 65                      |    |
|  | 480 VAC            | 35  | 65  | 100              | 35                       | 65  | 100              | 35                      |    |
|  | 600 VAC            | 25  | 35  | 50               | 25                       | 35  | 50               | 25                      |    |
| Number of Poles                              |                    | 2, 3, 4   |     |                  |                          | 2, 3, 4   |                  |                         |    |
| Ampere Range                                 |                    | 63-400A   |     |                  |                          | 315-630A  |                  |                         |    |
| Trip Units                                   |                    | <br>Adjustable Thermal Magnetic<br><br>Digitrip RMS 310 |     |                  |                          | <br>Adjustable Thermal Magnetic<br><br>Digitrip RMS 310 |                  |                         |    |
| Interchangeable                              |                    | ■   |     |                  |                          | ■   |                  |                         |    |
| Built-in                                     |                    | ■   |     |                  |                          | ■   |                  |                         |    |
| Thermal Magnetic                             | Fixed Thermal      | ■   |     |                  |                          | ■   |                  |                         |    |
|  | Adjustable Thermal | ■   |     |                  |                          | ■   |                  |                         |    |
|  | Magnetic           | Adjustable  |     |                  |                          | Adjustable  |                  |                         |    |
| Solid State rms <sup>②③</sup>                | LS                 | Standard  |     |                  |                          | Standard  |                  |                         |    |
|  | LSI                | Optional  |     |                  |                          | Optional  |                  |                         |    |
|  | LSG                | Optional <sup>③</sup>   |     |                  |                          | Optional  |                  |                         |    |
|  | LSIG               | Optional <sup>③</sup>   |     |                  |                          | Optional  |                  |                         |    |
| Dimensions (mm)                              |                    | H   | W   | D                | H                        | W   | D                |                         |    |
|  | 1-Pole             | —   | —   | —                | —                        | —   | —                |                         |    |
|  | 2-Pole             | —   | —   | —                | —                        | —   | —                |                         |    |
|  | 3-Pole             | 258   | 140 | 104              | 630A = 273<br>800A = 406 | 210   | 104              |                         |    |
| 4-Pole                                       |                    | 183   |     |                  | 280                      |   |                  |                         |    |
| Weight (approximate) Kgs.                    |                    | 3-Pole  |     | 4-Pole           |                          | 3-Pole  |                  | 4-Pole                  |    |
|  |                    | 6.1   |     | 7.3              |                          | 630A = 9.4/800A = 11.3  |                  | 630A = 11.1/800A = 14.4 |    |

① Not KEMA-KEUR listed. R-frame scheduled for 2001.  
 ② 2 poles in series.  
 ③ Not suitable for DC application. 4-pole ground fault not available.

## Cutler-Hammer Frame Sizes N and R

### Electrical Characteristics

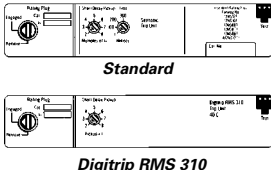
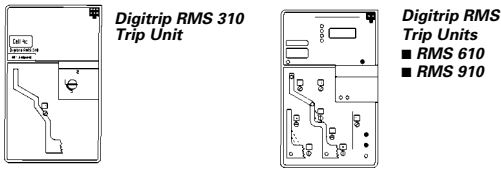
|  |                    | N  |                 |                  |     | R  |                  |                  |  |
|--|--------------------|--|-----------------|------------------|-----|--|------------------|------------------|--|
| <b>Maximum Rated Current (Amperes)</b>       |                    | 800, 1250  |                 |                  |     | 1600   | 1600, 2000, 2500 |                  |  |
| <b>Breaker Type</b>                          |                    | NW   | HNW             | NWC <sup>①</sup> | NW  | RW <sup>①</sup>  |                  | RWC <sup>①</sup> |  |
| <b>Breaker Capacity (kA rms) AC 50-60 Hz</b> |                    |  |                 |                  |     |  |                  |                  |  |
| IEC 947-2                                    | 220-240 VAC        | $I_{CU}$   | 85              | 100              | 200 | 85   | 135              | 200              |  |
|  |                    | $I_{CS}$   | 85              | 100              | 100 | 85   | 100              | 100              |  |
|  | 380-415 VAC        | $I_{CU}$   | 50              | 70               | 100 | 50   | 70               | 100              |  |
|  |                    | $I_{CS}$   | 50              | 50               | 50  | 50   | 50               | 50               |  |
|  | 660-690 VAC        | $I_{CU}$   | 20 <sup>②</sup> | 25 <sup>②</sup>  | 35  | 20 <sup>②</sup>  | 25               | 35               |  |
|  |                    | $I_{CS}$   | 10              | 13               | 18  | 10   | 13               | 18               |  |
| 250 VDC <sup>③</sup>                         | $I_{CU}$           | —  | —               | —                | —   | —  | —                |                  |  |
|  | $I_{CS}$           | —  | —               | —                | —   | —  | —                |                  |  |
| NEMA   | 240 VAC            | 65   | 100             | 200              | 100 | 125  | 200              |                  |  |
|  | 480 VAC            | 50   | 65              | 100              | 65  | 65   | 100              |                  |  |
|  | 600 VAC            | 25   | 35              | 50               | 35  | 50   | 65               |                  |  |
| <b>Number of Poles</b>                       |                    | 2, 3, 4  |                 |                  |     | 3  | 3, 4             |                  |  |
| <b>Ampere Range</b>                          |                    | 400-1250A  |                 |                  |     | 1600A  | 800-2500A        |                  |  |
| <b>Trip Units</b>                            |                    |  <p>Standard<br/>Digitrip RMS 310</p> |                 |                  |     |  <p>Digitrip RMS 310 Trip Unit<br/>Digitrip RMS Trip Units<br/>■ RMS 610<br/>■ RMS 910</p> |                  |                  |  |
| Interchangeable                              |                    | —  |                 |                  |     | —  |                  |                  |  |
| Built-in                                     |                    | ■  |                 |                  |     | ■  |                  |                  |  |
| Thermal Magnetic                             | Fixed Thermal      | —  |                 |                  |     | —  |                  |                  |  |
|  | Adjustable Thermal | —  |                 |                  |     | —  |                  |                  |  |
|  | Magnetic           | —  |                 |                  |     | —  |                  |                  |  |
| Solid State rms <sup>④</sup>                 | LS                 | Standard   |                 |                  |     | Standard (LI is Optional in Digitrip 510, 610, 810 and 910)  |                  |                  |  |
|  | LSI                | Optional   |                 |                  |     | Optional   |                  |                  |  |
|  | LSG                | Optional   |                 |                  |     | Optional (LIG is Optional in Digitrip 510, 610, 810 and 910)   |                  |                  |  |
|  | LSIG               | Optional   |                 |                  |     | Optional   |                  |                  |  |
| Dimensions (mm)                              | 1-Pole             | H  | W               | D                | H   | W  | D                |                  |  |
|  |                    | —  | —               | —                | —   | —  | —                |                  |  |
|  | 2-Pole             | —  | —               | —                | —   | —  | —                |                  |  |
|  |                    | —  | —               | —                | —   | —  | —                |                  |  |
|  | 3-Pole             | 406  | 210             | 104              | 406 | 394  | 229              |                  |  |
| 4-Pole                                       | —                  | 280  | —               | —                | 508 | —  |                  |                  |  |
| <b>Weight (approximate) Kgs.</b>             |                    | 3-Pole   |                 | 4-Pole           |     | 3-Pole   |                  | 4-Pole           |  |
|  |                    | 21.3   |                 | 28.3             |     | 47   |                  | 54               |  |

① Not KEMA-KEUR listed. R-frame scheduled for 2001.

② IEC 60947-2 H.5 Annex H is not KEMA-KEUR tested.

③ 2 poles in series.

④ Not suitable for DC application. 4-pole ground fault not available.

Cutler-Hammer Frame Sizes G through R

Electrical Characteristics

| Technical Data   | G-Frame  | E125-Frame   | J250-Frame   | K-Frame  | L-Frame  | N-Frame  | R-Frame  |
|--|--|--|--|--|--|--|--|
| Maximum Rated Current $I_n$ Depending on the Version   | 100A   | 125A   | 200/250A   | 315/400A   | 500/630/800A   | 800/1250A  | 1600/2000/2500A  |
| Rated Insulation Voltage $U_i$ , According to IEC 947-2<br>Main Conducting Paths<br>Auxiliary Circuits   | 1-Pole = 250 VAC<br>2,3-Pole = 415 VAC<br>690 VAC                    | 750 VAC<br>690 VAC   | 750 VAC<br>690 VAC   | 750 VAC<br>690 VAC   | 750 VAC<br>690 VAC   | 750 VAC<br>690 VAC   | 750 VAC<br>690 VAC   |
| Rated Impulse Withstand Voltage $U_{imp}$<br>Main Conducting Paths<br>Auxiliary Circuits   | 1-Pole = 4 kV<br>2,3-Pole = 6 kV<br>4 kV                             | 6 kV<br>4 kV   | 8 kV<br>4 kV   | 8 kV<br>4 kV   | 8 kV<br>4 kV   | 8 kV<br>4 kV   | 8 kV<br>4 kV   |
| Rated Operational Voltage $U_e$<br>IEC<br>NEMA   | 440 VAC<br>480 VAC   | 440 VAC<br>600Y/347 VAC  | 690 VAC<br>600 VAC   | 690 VAC<br>600 VAC   | 690 VAC<br>600 VAC   | 690 VAC<br>600 VAC   | 690 VAC<br>600 VAC   |
| Permissible Ambient Temperature  | -20 to +70°C   | -20 to +70°C   | -20 to +70°C   | -20 to +70°C   | -20 to +70°C   | -5 to +60°C  | -5 to +60°C  |
| Permissible Load for Various Ambient Temperatures Close to the Circuit Breaker, Related to the Rated Current of the Circuit Breaker<br>■ Circuit Breakers for Plant Protection<br>- At 40°C<br>- At 50°C<br>- At 55°C<br>- At 60°C<br>- At 70°C<br>■ Circuit Breakers for Motor Protection<br>- At 40°C<br>- At 50°C<br>- At 55°C<br>- At 60°C<br>- At 70°C<br>■ Circuit Breakers for Starter Combinations and Isolating Circuit Breakers<br>- At 40°C<br>- At 50°C<br>- At 55°C<br>- At 60°C<br>- At 70°C | -<br>100%<br>96%<br>93%<br>91%<br>86%                                | ① ②<br>100% 100%<br>96% 92%<br>93% 87%<br>91% 83%<br>86% 73%                                   | ① ②<br>100% 100%<br>96% 94%<br>94% 90%<br>92% 87%<br>88% 80%   | ① ②<br>100% 100%<br>96% 92%<br>93% 87%<br>90% 84%<br>85% 75%   | ① ②<br>100% 100%<br>96% 91%<br>93% 86%<br>90% 82%<br>84% 70%   | -<br>100%<br>91%<br>85%<br>81%<br>-  | -<br>100%<br>100%<br>100%<br>100%<br>-   |
| Rated Short Circuit Breaking Capacity (DC)<br>Not for Circuit Breakers for Motor Protection<br>(Time Constant $\tau = 10$ rms)<br>1 Conducting Path 2 Conducting Paths in Series 3 Conducting Paths in Series<br>For F to L up to:<br>250 VDC 440 VDC 660 VDC<br>NEMA (Time Constant $\tau = 8$ rms)<br>1 Conducting Path 2 Conducting Paths in Series<br>250 VDC<br>- 250 VDC   | -<br>10 kA (5 rms)   | 20 kA Max.<br>10 kA<br>22 kA   | 20 kA Max.<br>10 kA<br>22 kA   | 20 kA Max.<br>10 kA<br>22 kA   | 20 kA Max.<br>10 kA<br>22 kA   | -③<br>-③<br>-③   | -③<br>-③<br>-③   |
| Main Switch Characteristics According to IEC 947-2 in Combination with Lockable Rotary Drives  | -  | Yes  | Yes  | Yes  | Yes  | Yes  | Yes  |
| Rated Short Circuit Breaking Capacity According to IEC 947-2 (at AC 50/60 Hz)  | Rated Short Circuit Breaking Capacity See Table on Pages 4-5-6       |  |  |  |  |  |  |
| Endurance (Operating Cycles)   | 10,000   | 10,000   | 10,000   | 8,000  | 8,000  | 3,000  | 3,000  |
| Maximum Switching Frequency  | 300 1/h  | 300 1/h  | 240 1/h  | 240 1/h  | 240 1/h  | 60 1/h   | 20 1/h   |
| Conductor Cross Sections and Terminal Types for Main Conductors<br>■ Solid or Stranded<br>■ Finely Stranded with End Sleeve<br>■ Busbar<br>Tightening Torque for Box Terminals<br>Tightening Torque for Busbar Connection Pieces   | Box Terminals<br>2.5 to 50 mm <sup>2</sup><br>-<br>5.1 Nm<br>-       | Box Terminals<br>2.5 to 95 mm <sup>2</sup><br>2.5 to 50/70 mm <sup>2</sup><br>4/6 Nm<br>4.5 Nm | Box Terminals<br>50 to 150 mm <sup>2</sup><br>35 to 120 mm <sup>2</sup><br>20 Nm<br>15 Nm                    | Box Terminals<br>95 to 240 mm <sup>2</sup><br>70 to 150 mm <sup>2</sup><br>-<br>42 Nm<br>30 Nm               | Flat Bar Terminals<br>-<br>800A<br>31 Nm<br>6 Nm   | Flat Bar Terminals<br>-<br>-<br>Optional<br>31 Nm<br>50 Nm   | Flat Bar Terminals<br>-<br>-<br>Optional<br>-<br>37 Nm   |
| Conductor Cross Sections for Auxiliary Circuits with Terminal Connection or Terminal Strip<br>■ Solid<br>■ Finely Stranded with End Sleeve<br>■ With Brought-out Cable Ends<br>■ Tightening Torque for Fitting Screws  | 0.75 to 2.5 mm <sup>2</sup><br>0.75 to 2.5 mm <sup>2</sup><br>-<br>- | 0.75 to 2.5 mm <sup>2</sup><br>0.75 to 2.5 mm <sup>2</sup><br>-<br>-                           | 0.75 to 2.5 mm <sup>2</sup><br>0.75 to 2.5 mm <sup>2</sup><br>0.82 (AWG 18) mm <sup>2</sup><br>0.8 to 1.4 Nm | 0.75 to 2.5 mm <sup>2</sup><br>0.75 to 2.5 mm <sup>2</sup><br>0.82 (AWG 18) mm <sup>2</sup><br>0.8 to 1.4 Nm | 0.75 to 2.5 mm <sup>2</sup><br>0.75 to 2.5 mm <sup>2</sup><br>0.82 (AWG 18) mm <sup>2</sup><br>0.8 to 1.4 Nm | Up to 2x4 mm <sup>2</sup><br>Up to 2x2.5 mm <sup>2</sup><br>0.82 (AWG 18) mm <sup>2</sup><br>0.8 to 1.4 Nm | Up to 2x4 mm <sup>2</sup><br>Up to 2x2.5 mm <sup>2</sup><br>0.82 (AWG 18) mm <sup>2</sup><br>0.8 to 1.4 Nm |
| Power Loss per Circuit Breaker at Maximum Rated Current $I_n$ (The Power Losses of the Undervoltage Releases ("r" Releases) Must Be Observed if Necessary) at Three-Phase Symmetrical Load<br>■ For Plant Protection<br>■ As Isolating Circuit Breaker<br>■ For Starter Combinations<br>■ For Motor Protection   | 50 W<br>40 W<br>40 W<br>50 W   | 50 W<br>40 W<br>40 W<br>50 W   | 75 W<br>75 W<br>45 W<br>-  | 175 W<br>107 W<br>107 W<br>75 W  | 255 W<br>160 W<br>160 W<br>120 W   | 87/210 W<br>87/210 W<br>-<br>-   | 220/270/400 W<br>220/270/400 W<br>-<br>-   |
| Permissible Mounting Position  |  |  |  |  |  |  |  |

① Thermal overload release set to the lower value.

② Thermal overload release set to the upper value, respecting fixed-setting thermal overload releases.

③ Not suitable for DC switching.

## Cutler-Hammer Frame Sizes G through R

## Electrical Characteristics

| Technical Data   | G-Frame  | E125-Frame  | J250-Frame   | K-Frame  | L-Frame   | N-Frame  | R-Frame  |
|--|--|---|--|--|---|--|--|
| <b>Auxiliary Switches</b>  |  |   |  |  |   |  |  |
| Rated Thermal Current $I_{th}$<br>Rated Making Capacity  | 6A<br>10A  | 6A<br>20A   | 6A<br>20A  | 6A<br>20A  | 6A<br>20A   | 6A<br>20A  | 6A<br>20A  |
| AC (AC-15)<br>– Rated Operational Voltage<br>– Rated Operational Current   | 240V<br>6A   | 230/400/600V<br>6/3/0.25A   | 230/400/690V<br>6/3/0.25A  | 230/400/690V<br>6/3/0.25A  | 230/400/690V<br>6/3/0.25A   | 230/400/690V<br>6/3/0.25A  | 230/400/690V<br>6/3/0.25A  |
| DC (DC-13)<br>– Rated Operational Voltage<br>– Rated Operational Current   | 24<br>5  | 24/125/250V<br>6/0.5/0.25A  | 24/125/240V<br>6/0.5/0.15A   | 24/125/240V<br>6/0.5/0.15A   | 24/125/240V<br>6/0.5/0.15A  | 24/125/240V<br>6/0.5/0.15A   | 24/125/240V<br>6/0.5/0.15A   |
| Back-up Fuse<br>Miniature Circuit Breaker  | 6A<br>6A   | 6/4/4A<br>6/4A  | 6/4/4A<br>6/4A   | 6/4/4A<br>6/4A   | 6/4/4A<br>6/4A  | 6/4/4A<br>6/4A   | 6/4/4A<br>6/4A   |
| <b>Releases</b>  |  |   |  |  |   |  |  |
| Undervoltage Releases ("r" Releases)<br>Response Voltage:<br>– Drop (Breaker Tripped) $U_s$<br>– Pickup (Breaker May Be Switched on) $U_s$   | 35-70%<br>85-110%  | 35-70%<br>85-110%   | 35-70%<br>85-110%  | 35-70%<br>85-110%  | 35-70%<br>85-110%   | 35-70%<br>85-110%  | 35-70%<br>85-110%  |
| Power Consumption in Continuous Operation at:<br>– AC 50/60 Hz 12V<br>– AC 50/60 Hz 24V<br>– AC 50/60 Hz 48-60V<br>– AC 50/60 Hz 110-127V<br>– AC 50/60 Hz 208-240V<br>– AC 50/60 Hz 380-500V<br>– DC 12V<br>– DC 24V<br>– DC 48-60V<br>– DC 110-125V<br>– DC 220-250V                 | –<br>5.3 VA<br>1.5 VA<br>1.8 VA<br>1.4 VA<br>4.8 VA<br>–<br>–<br>–<br>–<br>– | 0.95 VA<br>0.72 VA<br>1.15-1.78 VA<br>0.96 -1.25 VA<br>1.28 -1.68 VA<br>2.2 -3.9 VA<br>0.88 VA<br>0.70 VA<br>1.12-1.76 VA<br>0.94-1.21 VA<br>1.45-1.86 VA | 1.9 VA<br>3.9 VA<br>2.5-3.8 VA<br>1.8 -2.4 VA<br>2.7-3.8 VA<br>3.4-5.8 VA<br>1.6 W<br>3.1 W<br>2.0-3.1 W<br>1.6-2.2 W<br>3.1-4 W | 1.9 VA<br>3.9 VA<br>2.5-3.8 VA<br>1.8 -2.4 VA<br>2.7-3.8 VA<br>3.4-5.8 VA<br>1.6 W<br>3.1 W<br>2.0-3.1 W<br>1.6-2.2 W<br>3.1-4 W | 1.9 VA<br>3.9 VA<br>2.5-3.8 VA<br>1.8-2.4 VA<br>2.7-3.8 VA<br>3.4-5.8 VA<br>1.6 W<br>3.1 W<br>2.0-3.1 W<br>1.6-2.2 W<br>3.1-4 W | 1.9 VA<br>2.4 VA<br>2.3-4.1 VA<br>3.4-4.2 VA<br>4.8-6.5 VA<br>6.8-12.0 VA<br>2.6 W<br>3.6 W<br>3.5-5.5 W<br>2.9-3.6 W<br>4.8-6.3 W | 2.9 VA<br>3.1 VA<br>3.4-6.0 VA<br>3.3-3.8 VA<br>4.2-7.2 VA<br>3.8 10.0 VA<br>3.4 W<br>4.3 W<br>4.8-7.2 W<br>3.3-3.8 W<br>6.6-7.5 W   |
| Maximum Opening Time   | 50 ms  | 50 ms   | 50 ms  | 50 ms  | 50 ms   | 80 ms  | 80 ms  |
| <b>Shunt Trips</b>   |  |   |  |  |   |  |  |
| Shunt Trips ("f" Releases)<br>Response Voltage:<br>– Pickup (Breaker Tripped) $U_s$  | 70-110%  | 70-110%   | 0-110%   | 70-110%  | 70-110%   | 70-110%  | 70-110%  |
| Power Consumption in (Short Time) at:<br>– AC 50/60 Hz 12-24V<br>– AC 50/60 Hz 48-60V<br>– AC 50/60 Hz 48-127V<br>– AC 50/60 Hz 110-240V<br>– AC 50/60 Hz 380-440V<br>– AC 50/60 Hz 380-600V<br>– AC 50/60 Hz 480-600V<br>– DC 12-24V<br>– DC 48-60V<br>– DC 110-125V<br>– DC 220-250V | –<br>–<br>–<br>135-500 VA<br>–<br>–<br>–<br>–<br>–<br>–<br>–<br>–            | 10-41 VA<br>139-210 VA<br>–<br>83-360 VA<br>–<br>418-1080 VA<br>–<br>29-120 W<br>475-720 W<br>99-121 W<br>–   | 87-405 VA<br>710-1105 VA<br>–<br>66-432 VA<br>127-188 VA<br>–<br>34-60 VA<br>164-631 W<br>830-1580 W<br>112-150 W<br>40-58 W     | 87-405 VA<br>710-1105 VA<br>–<br>66-432 VA<br>127-188 VA<br>–<br>34-60 VA<br>164-631 W<br>830-1580 W<br>112-150 W<br>40-58 W     | 81-701 VA<br>58-90 VA<br>–<br>118-665 VA<br>125-181 VA<br>–<br>43-79 VA<br>79-1000 W<br>18-31 W<br>112-150 W<br>38-52 W         | 86-631 VA<br>48-71 VA<br>–<br>81-505 VA<br>43-68 VA<br>–<br>41-69 VA<br>46-405 W<br>58-94 W<br>74-98 W<br>38-49 W                  | 177-1207 VA<br>443-731 VA<br>–<br>323-1466 VA<br>1193-1641 VA<br>–<br>197-312 VA<br>289-865 W<br>468-696 W<br>363-473 W<br>513-665 W |
| Maximum Load Duration  | Interrupts Automatically   |   |  |  |   |  |  |
| Maximum Opening Time   | 50 ms  | 50 ms   | 50 ms  | 50 ms  | 50 ms   | 62 ms  | 62 ms  |



## Electrical Characteristics

### DC Switching Duty

The E- to L-Frame circuit breakers are also suitable for switching dc currents.

The N- and R-Frame circuit breakers, FWMP, KWMP, and LWMP circuit breakers for motor protection are not suitable for dc currents due to the solid state overcurrent release system.

For switching dc currents, however, the maximum permissible dc voltage per conducting path has to be considered.

For voltages higher than 250 volts, the series connection of two or three conducting paths is required.

As the current has to flow through all conducting paths so as to maintain the thermal tripping characteristics, the following circuit arrangements are recommended. With dc, the trip values of the instantaneous short circuit release ("n" release) are increased by 30 to 40%.

### For 3- and 4-Pole Circuit Breakers

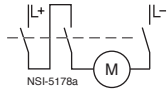
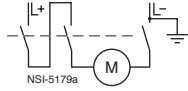
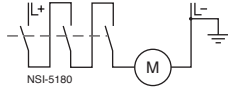
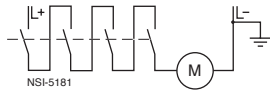
| Proposed Circuit   | Maximum Permissible VDC $U_e$ | Remarks  |
|--|-------------------------------|--|
|  <p>NSI-5178a</p> | 250 VDC                       | Double-pole switching.<br>If there is no risk of an earth fault, or if any earth fault which occurs is immediately eliminated (earth fault monitoring), the maximum permissible dc voltage can be 600 volts. |
|  <p>NSI-5179a</p> | 440 VDC                       | Double-pole switching (earth system).<br>The earthed pole must always be assigned to the individual conducting path, so that two paths are always in series in the event of an earth fault.                  |
|  <p>NSI-5180</p>  | 600 VDC                       | Single-pole switching (earthed system).<br>Three conducting paths in series. The earthed pole must be assigned to the nonswitched conducting path.   |
|  <p>NSI-5181</p>  | 750 VDC                       | Single-pole switching (earthed system).<br>Four conducting paths in series. The earthed pole must be assigned to the nonswitched conducting path.  |

Cutler-Hammer Frame Sizes K through R

## Multi-Function Electronic Trip Units for All Applications

### Digitrip™ RMS Trip Units

#### True rms Sensing

Digitrip RMS Trip Units utilize our proprietary SURE™ Chip and SuRE Plus™ Chip microprocessor-based intelligence to provide true rms sensing, permitting increased accuracy and reliable system protection. True rms sensing is not susceptible to nuisance tripping when waveforms containing high harmonic currents are present.

#### Digitrip RMS 310

Digitrip RMS 310 Electronic Trip Units are available with Cutler-Hammer Circuit Breakers K-, L-, N- and R-Frames 63 through 2500 amperes. Digitrip RMS 310 Trip Units are available in four styles with either fixed or adjustable rating plugs which establishes the continuous ampere rating of the breaker.

#### Rating Plugs

Digitrip RMS 310 Trip Units incorporate rating plugs that are interchangeable within a specific circuit breaker frame. This provides the user with versatility when establishing the continuous current rating of a breaker. Rating plugs are frequency sensitive and may be specified for 50 / 60 Hz applications. Both fixed and adjustable rating plugs are available, providing further flexibility when applied to selectively coordinated systems.

Note: *Digitrip RMS rating plugs are not interchangeable with SELTRONIC™ rating plugs.*

#### Curve Shaping

When selectively coordinated systems are called for, Digitrip RMS 310 will provide a cost-effective solution for a variety of applications.

The standard Digitrip RMS 310 includes an adjustable short time pickup setting encompassing an  $I^2t$  ramp function which provides the basic LS curve shaping function.

The optional Digitrip RMS 310 provides additional flat response short time delay adjustments on an instantaneous setting to provide LSI curve shaping capability.

Both Digitrip RMS 310 Trip Units are available with ground fault pickup and flat response ground fault delay which provide the trip unit with full function LSG and LSIG curve shaping flexibility.

Digitrip RMS 310 Trip Units can effectively coordinate with both sophisticated upstream power breakers as well as downstream thermal magnetic breakers...making Digitrip RMS 310 Trip Units the cost-effective reliable choice for selectively coordinated systems.

#### Thermal Memory

All Digitrip RMS Trip Units incorporate a long delay and, when ordered with ground, a ground fault thermal memory feature. Thermal memory prevents the system from cumulative overheating due to repeated overcurrent events that may occur in quick succession.

### Digitrip RMS 610 and 910

Digitrip RMS 610, and 910 Trip Units are available with Cutler-Hammer R-Frame Circuit Breakers 800 through 2500 amperes. Digitrip 610 and 910 Trip Units provide unparallelled system protection with fixed rating plugs to establish the continuous ampere rating of the breaker.

#### Curve Shaping

Digitrip RMS 610 and 910 Trip Units are available with up to nine curve shaping choices achieved by adjusting up to seven switches on the front of the unit for optimum system coordination. Maximum curve shaping flexibility is provided by dependent long and short delay adjustments that are long delay pickup ( $I_r$ ) based, depicted on the front of the unit by the blue portion of the time-current curve.

Additional coordination capability can be provided by utilizing the short delay and ground fault zone selective interlocking features available on these trip units.

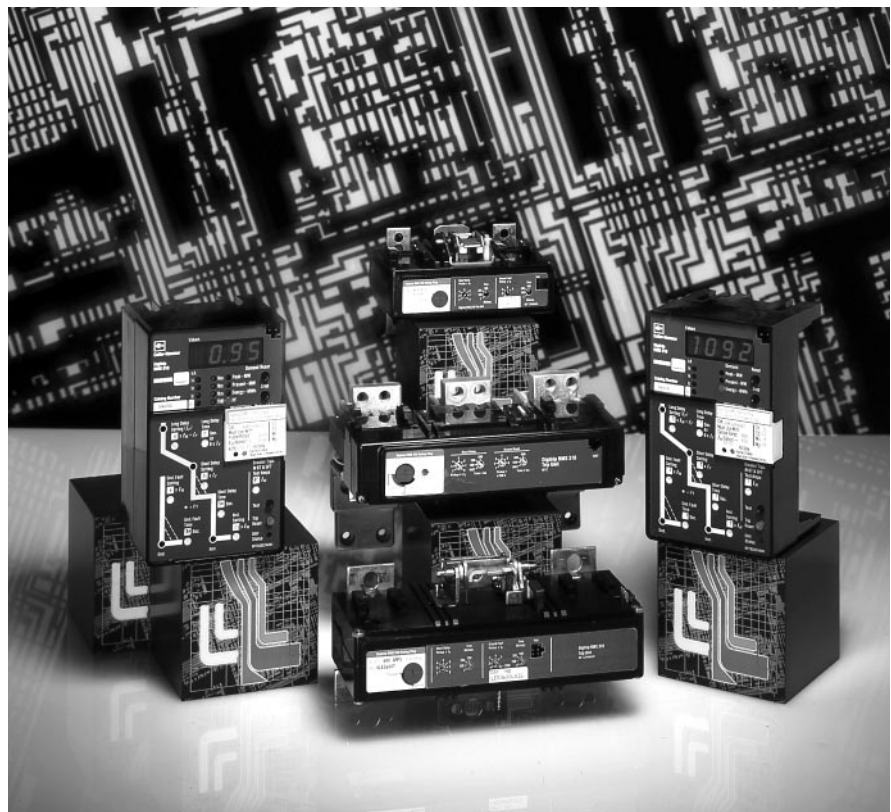

R-Frame Digitrip RMS 310, 610 and 910 Trip Units (Noninterchangeable)

### Cutler-Hammer Frame Size R

#### System Diagnostics

All four Digitrip RMS models of trip units provide long delay, short delay, instantaneous, and ground fault cause of trip LEDs on the front of the unit. Digitrip RMS 610 and 910 also offer a magnitude of trip information as well as remote signal contacts for improved system diagnostics.

#### System Monitoring

Digitrip 610 and 910 Trip Units have the capability to monitor phase currents as well as neutral or ground currents. This information is displayed on a large digital display mounted on the unit.

Digitrip RMS 910 Trip Units can also provide the user with power and energy monitoring capability. Peak power demand, present power

demand, and total energy as well as forward and reverse energy can be monitored with this unit.

Digitrip RMS 910 Trip Units have the additional capability of monitoring line to line voltage as well as system power factor. Both parameters are displayed in the digital display window and are supported by LEDs to indicate which parameter is being displayed.

#### Harmonics Monitoring

Digitrip RMS 910 Trip Units are capable of displaying values of current harmonics in the digital display window. Percentage of harmonic content can be monitored for each phase, neutral or ground, up to the 27th harmonic. Additionally, a total harmonic distortion value can be calculated and displayed.

#### Communications







Digitrip RMS 810 and 910 have built-in communications options to allow all protection, monitoring, and control information to be transmitted back to a central location via the Cutler-Hammer PowerNet System.

#### Field Testing

Integral field testing capability is provided on all 610 and 910 Trip Units. No additional test set is needed to perform both trip and no trip field testing.

## Cutler-Hammer Frame Sizes K through R

## Digitrip RMS Electronic Trip Unit Selection Guide

| Digitrip | RMS 310   | RMS 610  | RMS 910   |
|----------|---|--|---|
|          |  |  |  |
|          |  |  |   |
|          |  |  |   |
|          |  |  |   |

### Breaker Type

|                             |                         |            |            |
|-----------------------------|-------------------------|------------|------------|
| Cutler-Hammer Frame(s)      | K-, L-, N- and R-Frames | R-Frame    | R-Frame    |
| Ampere Rating               | 70A-2500A               | 800A-2500A | 800A-2500A |
| Interrupting Rating at 415V | 35, 70, 100 kA          | 70, 100 kA | 70, 100 kA |

### Trip Unit Sensing

|             |     |     |     |
|-------------|-----|-----|-----|
| rms Sensing | Yes | Yes | Yes |
|-------------|-----|-----|-----|

### Protection and Coordination

| Protection    | Ordering Options            | LS, LSG                           | LSI, LSIG                         | LI, LSI, LIG, LSG, LSIG          | LI, LS, LSI, LIG, LSG, LSIG      |
|---------------|-----------------------------|-----------------------------------|-----------------------------------|----------------------------------|----------------------------------|
|               | Fixed Rating Plug ( $I_n$ ) | Yes                               | Yes                               | Yes                              | Yes                              |
|               | Overtemperature Trip        | Yes                               | Yes                               | Yes                              | Yes                              |
| Long Delay    | Adjustable Rating Plug (In) | Yes                               | Yes                               | No                               | No                               |
|               | Long Delay Setting          | 0.5-1.0 ( $I_n$ ) <sup>①</sup>    | 0.5-1.0 ( $I_n$ ) <sup>①</sup>    | 0.5-1.0 ( $I_n$ )                | 0.5-1.0 ( $I_n$ )                |
|               | Long Delay Time $I^2t$      | 12 Seconds                        | 12 Seconds                        | 2-24 Seconds                     | 2-24 Seconds                     |
|               | Long Delay Thermal Memory   | Yes                               | Yes                               | Yes                              | Yes                              |
|               | High Load Alarm             | No                                | No                                | 0.85 x $I_r$                     | 0.85 x $I_r$                     |
| Short Delay   | Short Delay Setting         | 200-800% x ( $I_n$ ) <sup>⑤</sup> | 200-800% x ( $I_n$ ) <sup>⑤</sup> | 200-600% S1 & S2 x ( $I_r$ )     | 200-600% S1 & S2 x ( $I_r$ )     |
|               | Short Delay Time $I^2t$     | 100 ms                            | No                                | 100-500 ms                       | 100-500 ms                       |
|               | Short Delay Time Flat       | No                                | 1-300 ms                          | 100-500 ms                       | 100-500 ms                       |
|               | Short Delay Time ZSI        | No                                | No                                | Yes                              | Yes                              |
| Instantaneous | Instantaneous Setting       | No                                | 200-800% x ( $I_n$ )              | 200-600% M1 & M2 x ( $I_n$ )     | 200-600% M1 & M2 x ( $I_n$ )     |
|               | Discriminator               | No                                | No                                | Yes <sup>④</sup>                 | Yes <sup>④</sup>                 |
|               | Instantaneous Override      | Yes                               | Yes                               | Yes                              | Yes                              |
| Ground Fault  | Ground Fault Setting        | Var/Frame <sup>③</sup>            | Var/Frame <sup>③</sup>            | 25-100% x ( $I_n$ ) <sup>③</sup> | 25-100% x ( $I_n$ ) <sup>③</sup> |
|               | Fault Delay $I^2t$          | No                                | No                                | 100-500 ms                       | 100-500 ms                       |
|               | Ground Fault Delay Flat     | 1-500 ms                          | 1-500 ms                          | 1-500 ms                         | 1-500 ms                         |
|               | Ground Fault ZSI            | No                                | No                                | Yes                              | Yes                              |
|               | Ground Fault Thermal Memory | Yes                               | Yes                               | Yes                              | Yes                              |

### System Diagnostics

|                               |    |    |     |     |
|-------------------------------|----|----|-----|-----|
| Cause of Trip LEDs            | No | No | Yes | Yes |
| Magnitude of Trip Information | No | No | Yes | Yes |
| Remote Signal Contacts        | No | No | Yes | Yes |

### System Monitoring

|                           |                 |                 |     |     |
|---------------------------|-----------------|-----------------|-----|-----|
| Digital Display           | No              | No              | Yes | Yes |
| Current                   | No              | No              | Yes | Yes |
| Voltage                   | No              | No              | No  | Yes |
| Power and Energy          | No <sup>②</sup> | No <sup>②</sup> | No  | Yes |
| Power Quality - Harmonics | No              | No              | No  | Yes |
| Power Factor              | No              | No              | No  | Yes |

### System Communications

|          |    |    |    |     |
|----------|----|----|----|-----|
| PowerNet | No | No | No | Yes |
|----------|----|----|----|-----|

### Field Testing

|                             |          |          |          |          |
|-----------------------------|----------|----------|----------|----------|
| Testing Method <sup>①</sup> | Test Set | Test Set | Integral | Integral |
|-----------------------------|----------|----------|----------|----------|

① Set by adjustable rating plug  
 ② Yes, with addition of Energy Sentinal.  
 ③ Not to exceed 1200A.

④ LS, LSG only.  
 ⑤ 2500A R-frame 200-600% x ( $I_n$ )

$I_n$  = Rating plug rating.  
 $I_r$  = LDPU setting.

**Selection Guide and Ordering Information**

|   |   |        |                                  |
|---|---|--------|----------------------------------|
| Maximum Continuous Ampere Rating at 40°C <sup>①</sup> | Standard Interrupting Capacity Catalogue Number |        |                                  |
|   | U <sub>e</sub> Maximum 240 VAC                  |        | U <sub>e</sub> Maximum 440 VAC   |
|   | 20 kA I <sub>cu</sub> at 240 VAC                |        | 25 kA I <sub>cu</sub> at 415 VAC |
|   | Type GWF <sup>②</sup>                           |        |                                  |
|   | 1-Pole  | 2-Pole | 3-Pole                           |

**Fixed Thermal/Fixed Magnetic Circuit Breakers  
Sealed Breakers with Noninterchangeable Trip Units and Line and Load Terminals**

|     |         |         |         |
|-----|---------|---------|---------|
| 16  | GWF1016 | GWF2016 | GWF3016 |
| 20  | GWF1020 | GWF2020 | GWF3020 |
| 25  | GWF1025 | GWF2025 | GWF3025 |
| 32  | GWF1032 | GWF2032 | GWF3032 |
| 40  | GWF1040 | GWF2040 | GWF3040 |
| 50  | GWF1050 | GWF2050 | GWF3050 |
| 63  | GWF1063 | GWF2063 | GWF3063 |
| 80  | GWF1080 | GWF2080 | GWF3080 |
| 100 | GWF1100 | GWF2100 | GWF3100 |

**Terminals (Factory Fitted Only)**

| Frame | Amperes | Terminal Type | Wire Type | Wire Range |
|-------|---------|---------------|-----------|------------|
| G     | 16-100  | Pressure Type | Copper    | 2.5-50     |

<sup>①</sup> Special 50°C rating available. Order by description.

<sup>②</sup> GWF is direct supersedure for GW fixed thermal magnetic breaker.

**Cutler-Hammer Frame Size E, 15-125 Amperes**

**Selection Guide and Ordering Information**

| Maximum Continuous Ampere Rating at 40°C <sup>①</sup> | IC Rating @ 415/480 V        |                              |                              |  |               |                              |  |               |
|---|------------------------------|------------------------------|------------------------------|--|---------------|------------------------------|--|---------------|
|   | 1-Pole                       |                              | 2-Pole <sup>②</sup>          |  | 3-Pole        |                              | 4-Pole   |               |
|   | Fixed Thermal Fixed Magnetic | Fixed Thermal Fixed Magnetic | Fixed Thermal Fixed Magnetic | Adjustable Thermal <sup>①</sup> Fixed Magnetic | Thermal Range | Fixed Thermal Fixed Magnetic | Adjustable Thermal <sup>①</sup> Fixed Magnetic | Thermal Range |

**Complete Circuit Breaker**  
**Includes Frame, Trip Unit, Standard Terminals, and Mounting Hardware**

| IEC/CE/UL/CSA 18/18 |            |            |            |            |         |            |            |         |
|---------------------|------------|------------|------------|------------|---------|------------|------------|---------|
| 15                  | EGB1015FFG | EGB2015FFG | EGB3015FFG | -          | -       | EGB4015FFG | -          | -       |
| 16                  | EGB1016FFG | EGB2016FFG | EGB3016FFG | -          | -       | EGB4016FFG | -          | -       |
| 20                  | EGB1020FFG | EGB2020FFG | EGB3020FFG | EGB3020AFG | 16-20   | EGB4020FFG | EGB4020AFG | 16-20   |
| 25                  | EGB1025FFG | EGB2025FFG | EGB3025FFG | EGB3025AFG | 20-25   | EGB4025FFG | EGB4025AFG | 20-25   |
| 30                  | EGB1030FFG | EGB2030FFG | EGB3030FFG | -          | -       | EGB4030FFG | -          | -       |
| 32                  | EGB1032FFG | EGB2032FFG | EGB3032FFG | EGB3032AFG | 25-32   | EGB4032FFG | EGB4032AFG | 25-32   |
| 35                  | EGB1035FFG | EGB2035FFG | EGB3035FFG | -          | -       | EGB4035FFG | -          | -       |
| 40                  | EGB1040FFG | EGB2040FFG | EGB3040FFG | EGB3040AFG | 32-40   | EGB4040FFG | EGB4040AFG | 32-40   |
| 45                  | EGB1045FFG | EGB2045FFG | EGB3045FFG | -          | -       | EGB4045FFG | -          | -       |
| 50                  | EGB1050FFG | EGB2050FFG | EGB3050FFG | EGB3050AFG | 40-50   | EGB4050FFG | -          | -       |
| 60                  | EGB1060FFG | EGB2060FFG | EGB3060FFG | -          | -       | EGB4060FFG | -          | -       |
| 63                  | EGB1063FFG | EGB2063FFG | EGB3063FFG | EGB3063AFG | 50-63   | EGB4063FFG | EGB4063AFG | 50-63   |
| 70                  | EGB1070FFG | EGB2070FFG | EGB3070FFG | -          | -       | EGB4070FFG | -          | -       |
| 80                  | EGB1080FFG | EGB2080FFG | EGB3080FFG | EGB3080AFG | 63-80   | EGB4080FFG | EGB4080AFG | 63-80   |
| 90                  | EGB1090FFG | EGB2090FFG | EGB3090FFG | -          | -       | EGB4090FFG | -          | -       |
| 100                 | EGB1100FFG | EGB2100FFG | EGB3100FFG | EGB3100AFG | 80-100  | EGB4100FFG | EGB4100AFG | 80-100  |
| 125                 | EGB1125FFG | EGB2125FFG | EGB3125FFG | -          | -       | EGB4125FFG | EGB4125AFG | 100-125 |
| 125                 | -          | -          | EGB3125KSG | EGB3125AFG | 100-125 | EGB4125KSG | -          | -       |

| IEC/CE/UL/CSA 25/25 |   |            |            |            |         |            |            |         |
|---------------------|---|------------|------------|------------|---------|------------|------------|---------|
| 15                  | - | EGE2015FFG | EGE3015FFG | -          | -       | EGE4015FFG | -          | -       |
| 16                  | - | EGE2016FFG | EGE3016FFG | -          | -       | EGE4016FFG | -          | -       |
| 20                  | - | EGE2020FFG | EGE3020FFG | EGE3020AFG | 16-20   | EGE4020FFG | EGE4020AFG | 16-20   |
| 25                  | - | EGE2025FFG | EGE3025FFG | EGE3025AFG | 20-25   | EGE4025FFG | EGE4025AFG | 20-25   |
| 30                  | - | EGE2030FFG | EGE3030FFG | -          | -       | EGE4030FFG | -          | -       |
| 32                  | - | EGE2032FFG | EGE3032FFG | EGE3032AFG | 25-32   | EGE4032FFG | EGE4032AFG | 25-32   |
| 35                  | - | EGE2035FFG | EGE3035FFG | -          | -       | EGE4035FFG | -          | -       |
| 40                  | - | EGE2040FFG | EGE3040FFG | EGE3040AFG | 32-40   | EGE4040FFG | EGE4040AFG | 32-40   |
| 45                  | - | EGE2045FFG | EGE3045FFG | -          | -       | EGE4045FFG | -          | -       |
| 50                  | - | EGE2050FFG | EGE3050FFG | EGE3050AFG | 40-50   | EGE4050FFG | -          | -       |
| 60                  | - | EGE2060FFG | EGE3060FFG | -          | -       | EGE4060FFG | -          | -       |
| 63                  | - | EGE2063FFG | EGE3063FFG | EGE3063AFG | 50-63   | EGE4063FFG | EGE4063AFG | 50-63   |
| 70                  | - | EGE2070FFG | EGE3070FFG | -          | -       | EGE4070FFG | -          | -       |
| 80                  | - | EGE2080FFG | EGE3080FFG | EGE3080AFG | 63-80   | EGE4080FFG | EGE4080AFG | 63-80   |
| 90                  | - | EGE2090FFG | EGE3090FFG | -          | -       | EGE4090FFG | -          | -       |
| 100                 | - | EGE2100FFG | EGE3100FFG | EGE3100AFG | 80-100  | EGE4100FFG | EGE4100AFG | 80-100  |
| 125                 | - | EGE2125FFG | EGE3125FFG | EGE3125AFG | 100-125 | EGE4125FFG | EGE4125AFG | 100-125 |
| 125                 | - | -          | EGE3125KSG | -          | -       | EGE4125KSG | -          | -       |

| IEC/CE/UL/CSA 40/35 |            |            |            |            |         |            |            |         |
|---------------------|------------|------------|------------|------------|---------|------------|------------|---------|
| 15                  | EGS1015FFG | EGS2015FFG | EGS3015FFG | -          | -       | EGS4015FFL | -          | -       |
| 16                  | EGS1016FFG | EGS2016FFG | EGS3016FFG | -          | -       | EGS4016FFL | -          | -       |
| 20                  | EGS1020FFG | EGS2020FFG | EGS3020FFG | EGS3020AFG | 16-20   | EGS4020FFL | EGS4020AFG | 16-20   |
| 25                  | EGS1025FFG | EGS2025FFG | EGS3025FFG | EGS3025AFG | 20-25   | EGS4025FFL | EGS4025AFG | 20-25   |
| 30                  | EGS1030FFG | EGS2030FFG | EGS3030FFG | -          | -       | EGS4030FFL | -          | -       |
| 32                  | EGS1032FFG | EGS2032FFG | EGS3032FFG | EGS3032AFG | 25-32   | EGS4032FFL | EGS4032AFG | 25-32   |
| 35                  | EGS1035FFG | EGS2035FFG | EGS3035FFG | -          | -       | EGS4035FFL | -          | -       |
| 40                  | EGS1040FFG | EGS2040FFG | EGS3040FFG | EGS3040AFG | 32-40   | EGS4040FFL | EGS4040AFG | 32-40   |
| 45                  | EGS1045FFG | EGS2045FFG | EGS3045FFG | -          | -       | EGS4045FFL | -          | -       |
| 50                  | EGS1050FFG | EGS2050FFG | EGS3050FFG | EGS3050AFG | 40-50   | EGS4050FFL | -          | -       |
| 60                  | EGS1060FFG | EGS2060FFG | EGS3060FFG | -          | -       | EGS4060FFL | -          | -       |
| 63                  | EGS1063FFG | EGS2063FFG | EGS3063FFG | EGS3063AFG | 50-63   | EGS4063FFL | EGS4063AFG | 50-63   |
| 70                  | EGS1070FFG | EGS2070FFG | EGS3070FFG | -          | -       | EGS4070FFL | -          | -       |
| 80                  | EGS1080FFG | EGS2080FFG | EGS3080FFG | EGS3080AFG | 63-80   | EGS4080FFL | EGS4080AFG | 63-80   |
| 90                  | EGS1090FFG | EGS2090FFG | EGS3090FFG | -          | -       | EGS4090FFL | -          | -       |
| 100                 | EGS1100FFG | EGS2100FFG | EGS3100FFG | EGS3100AFG | 80-100  | EGS4100FFL | EGS4100AFG | 80-100  |
| 125                 | EGS1125FFG | EGS2125FFG | EGS3125FFG | EGS3125AFG | 100-125 | EGS4125FFL | EGS4125AFG | 100-125 |
| 125                 | -          | -          | EGS3125KSG | -          | -       | EGS4125KSL | -          | -       |

| IEC/CE/UL/CSA 70/65 |            |            |            |            |         |            |            |         |
|---------------------|------------|------------|------------|------------|---------|------------|------------|---------|
| 15                  | EGH1015FFG | EGH2015FFG | EGH3015FFG | -          | -       | EGH4015FFG | -          | -       |
| 16                  | EGH1016FFG | EGH2016FFG | EGH3016FFG | -          | -       | EGH4016FFG | -          | -       |
| 20                  | EGH1020FFG | EGH2020FFG | EGH3020FFG | EGH3020AFG | 16-20   | EGH4020FFG | EGH4020AFG | 16-20   |
| 25                  | EGH1025FFG | EGH2025FFG | EGH3025FFG | EGH3025AFG | 20-25   | EGH4025FFG | EGH4025AFG | 20-25   |
| 30                  | EGH1030FFG | EGH2030FFG | EGH3030FFG | -          | -       | EGH4030FFG | -          | -       |
| 32                  | EGH1032FFG | EGH2032FFG | EGH3032FFG | EGH3032AFG | 25-32   | EGH4032FFG | EGH4032AFG | 25-32   |
| 35                  | EGH1035FFG | EGH2035FFG | EGH3035FFG | -          | -       | EGH4035FFG | -          | -       |
| 40                  | EGH1040FFG | EGH2040FFG | EGH3040FFG | EGH3040AFG | 32-40   | EGH4040FFG | EGH4040AFG | 32-40   |
| 45                  | EGH1045FFG | EGH2045FFG | EGH3045FFG | -          | -       | EGH4045FFG | -          | -       |
| 50                  | EGH1050FFG | EGH2050FFG | EGH3050FFG | EGH3050AFG | 40-50   | EGH4050FFG | EGH4050AFG | 40-50   |
| 60                  | EGH1060FFG | EGH2060FFG | EGH3060FFG | -          | -       | EGH4060FFG | -          | -       |
| 63                  | EGH1063FFG | EGH2063FFG | EGH3063FFG | EGH3063AFG | 50-63   | EGH4063FFG | EGH4063AFG | 50-63   |
| 70                  | EGH1070FFG | EGH2070FFG | EGH3070FFG | -          | -       | EGH4070FFG | -          | -       |
| 80                  | EGH1080FFG | EGH2080FFG | EGH3080FFG | EGH3080AFG | 63-80   | EGH4080FFG | EGH4080AFG | 63-80   |
| 90                  | EGH1090FFG | EGH2090FFG | EGH3090FFG | -          | -       | EGH4090FFG | -          | -       |
| 100                 | EGH1100FFG | EGH2100FFG | EGH3100FFG | EGH3100AFG | 80-100  | EGH4100FFG | EGH4100AFG | 80-100  |
| 125                 | EGH1125FFG | EGH2125FFG | EGH3125FFG | EGH3125AFG | 100-125 | EGH4125FFG | EGH4125AFG | 100-125 |
| 125                 | -          | -          | EGH3125KSG | -          | -       | EGH4125KSG | -          | -       |

① 16, 32, 63 A are not UL Listed ratings and adjustable thermal not UL listed.

② Two-pole E-Frame breakers available June 2001.

### Selection Guide and Ordering Information

#### Line and Load Terminals

E-Frame circuit breakers and moulded case switches have line and load terminals as standard equipment.

| Maximum Breaker Amperes                       | Terminal Body Material | Wire Type | Metric Wire Range mm <sup>2</sup> | AWG Wire Range | Catalogue Number Package of 3 Terminals |
|---|------------------------|-----------|-----------------------------------|----------------|---|
| <b>Standard Cu/Al Pressure Type Terminals</b> |                        |           |                                   |                |   |
| 125   | Steel                  | Cu        | 2.5-95                            | #14-3/0        | 3T125EF①                                |
| 125   | Aluminium              | Cu/Al     | 2.5-50                            | #14-1/0        | 3TA125EF                                |
| 125   | Aluminium              | Cu/Al     | 16-70                             | #6-3/0         | 3TA150EF                                |

#### Catalogue Number

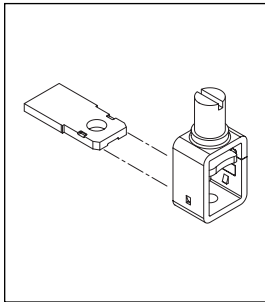

3T125EF①

Insert collar enclosing conductor as shown. Locate nut on top of conductor and tighten securely with screw and washer. Caution: Collar must surround conductor.

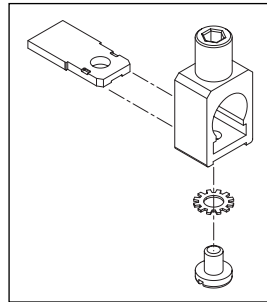

3TA125EF

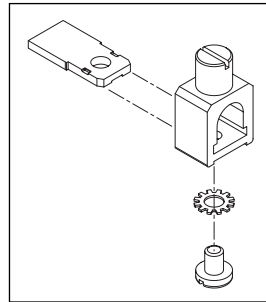

3TA150EF

Insert collar enclosing conductor and centre on extrusion. Tighten securely with screw and washer.

#### Endcap Kit

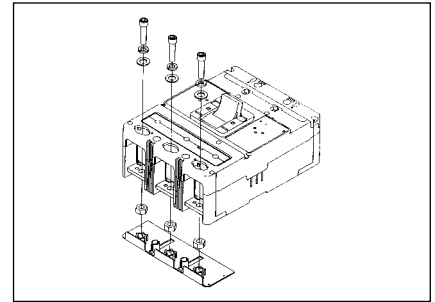

EF3RTWK 3-Pole – Metric,  
EF4RTWK 4-Pole – Metric,  
EF3RTDK 3-Pole – Imperial,  
EF4RTDK 4-Pole – Imperial

Endcap kits are used on E-frame breaker line load to connect bus bar or similar electrical connections. Includes hardware.

#### Control Wire Terminal Kit

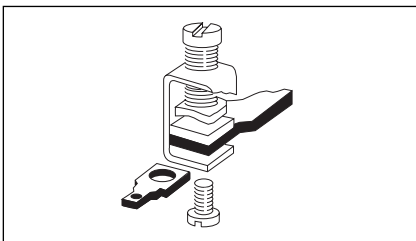

For use with steel or stainless steel① terminals only.

|                                     |
|-------------------------------------|
| Package of 12 – Priced Individually |
| Catalogue Number – EFCWTK           |

#### Interphase Barriers

The interphase barrier is available for extended insulation between circuit breaker poles. Specify quantity when ordering.

|                           |
|---------------------------|
| Package of 2              |
| Catalogue Number – EFIPBK |

#### Base Mounting Hardware

Base mounting hardware is included with a circuit breaker or moulded case switch. (Included with breaker).

| DIN Rail Adapter | Catalogue Number |
|------------------|------------------|
| 3- or 4-Pole     | EF34DIN          |

#### Terminal Shields

The terminal shield is available for line terminal areas in 2-, 3-, and 4-pole circuit breakers. Special terminal shields are also available for use when an electrical (solenoid) operator is mounted on the circuit breaker. The standard style number by pole for each terminal shield is for a package of 10 and is priced per each package. Special terminal shields are packaged individually.

| Number of Poles | Standard Package of 10                  | IP30 Protection |
|-----------------|---|-----------------|
|                 | Catalogue Numbers – Priced Individually |                 |
| 2               | EFTS2K                                  |                 |
| 3               | EFTS3K                                  |                 |
| 4               | EFTS4K                                  |                 |

#### Terminal End Covers

The terminal end cover is available for 3-pole circuit breakers only. Two conductor opening sizes are available. Specify quantity (one per circuit breaker) when ordering.

| Conductor Opening Diameter – mm (Inches) | Catalogue Number |
|--|------------------|
| 6.35 (0.25)                              | EFTC3K           |
| 10.41 (0.41)                             | EFTC4K           |

① Standard line and load terminals.

## Cutler-Hammer Frame Size J, 100-250 Amperes

### Selection Guide and Ordering Information

| Maximum Continuous Ampere Rating at 40°C                                    | Magnetic Range | IC Rating @ 415/480 V             |                                   |   |               |                                   |   |               |
|---|----------------|-----------------------------------|-----------------------------------|---|---------------|-----------------------------------|---|---------------|
|   |                | 2-Pole                            |                                   | 3-Pole  |               |                                   | 4-Pole <sup>①</sup>                                 |               |
|   |                | Fixed Thermal Adjustable Magnetic | Fixed Thermal Adjustable Magnetic | Adjustable Thermal Adjustable Magnetic <sup>②</sup> | Thermal Range | Fixed Thermal Adjustable Magnetic | Adjustable Thermal Adjustable Magnetic <sup>②</sup> | Thermal Range |
| <b>Complete Circuit Breaker</b>   |                |                                   |                                   |   |               |                                   |   |               |
| <b>Includes Frame, Trip Unit, Standard Terminals, and Mounting Hardware</b> |                |                                   |                                   |   |               |                                   |   |               |
| <b>IEC/CE/UL/CSA 25/25</b>  |                |                                   |                                   |   |               |                                   |   |               |
| 63  | 315-630        | —                                 | JGE3063FAG <sup>②</sup>           | JGE3063AAG  | 40-63         | JGE4063FAG <sup>②</sup>           | JGE4063AAG  | 40-63         |
| 70  | 350-700        | JGE2070FAG                        | JGE3070FAG                        | —   | —             | JGE4070FAG                        | —   | —             |
| 90  | 450-900        | JGE2090FAG                        | JGE3090FAG                        | —   | —             | JGE4090FAG                        | —   | —             |
| 100   | 500-1000       | JGE2100FAG                        | JGE3100FAG                        | JGE3100AAG  | 63-100        | JGE4100FAG                        | JGE4100AAG  | 63-100        |
| 125   | 625-1250       | JGE2125FAG                        | JGE3125FAG                        | JGE3125AAG  | 100-125       | JGE4125FAG                        | JGE4125AAG  | 100-125       |
| 150   | 750-1500       | JGE2150FAG                        | JGE3150FAG                        | —   | —             | JGE4150FAG                        | —   | —             |
| 160   | 800-1600       | —                                 | JGE3160FAG <sup>②</sup>           | JGE3160AAG  | 125-160       | JGE4160FAG <sup>②</sup>           | JGE4160AAG  | 125-160       |
| 175   | 875-1750       | JGE2175FAG                        | JGE3175FAG                        | —   | —             | JGE4175FAG                        | —   | —             |
| 200   | 1000-2000      | JGE2200FAG                        | JGE3200FAG                        | JGE3200AAG  | 160-200       | JGE4200FAG                        | JGE4200AAG  | 160-200       |
| 225   | 1125-2250      | JGE2225FAG                        | JGE3225FAG                        | —   | —             | JGE4225FAG                        | —   | —             |
| 250   | 1250-2500      | JGE2250FAG                        | JGE3250FAG                        | JGE3250AAG  | 200-250       | JGE4250FAG                        | JGE4250AAG  | 200-250       |
| 250   | 1250-2500      | ③                                 | JGE3250KSG                        | —   | —             | JGE4250KSG                        | —   | —             |

| <b>IEC/CE/UL/CSA 40/35</b> |           |            |                         |            |         |                         |            |         |
|----------------------------|-----------|------------|-------------------------|------------|---------|-------------------------|------------|---------|
| 63                         | 315-630   | —          | JGS3063FAG <sup>②</sup> | JGS3063AAG | 40-63   | JGS4063FAG <sup>②</sup> | JGS4063AAG | 40-63   |
| 70                         | 350-700   | JGS2070FAG | JGS3070FAG              | —          | —       | JGS4070FAG              | —          | —       |
| 90                         | 450-900   | JGS2090FAG | JGS3090FAG              | —          | —       | JGS4090FAG              | —          | —       |
| 100                        | 500-1000  | JGS2100FAG | JGS3100FAG              | JGS3100AAG | 63-100  | JGS4100FAG              | JGS4100AAG | 63-100  |
| 125                        | 625-1250  | JGS2125FAG | JGS3125FAG              | JGS3125AAG | 100-125 | JGS4125FAG              | JGS4125AAG | 100-125 |
| 150                        | 750-1500  | JGS2150FAG | JGS3150FAG              | —          | —       | JGS4150FAG              | —          | —       |
| 160                        | 800-1600  | —          | JGS3160FAG <sup>②</sup> | JGS3160AAG | 125-160 | JGS4160FAG <sup>②</sup> | JGS4160AAG | 125-160 |
| 175                        | 875-1750  | JGS2175FAG | JGS3175FAG              | —          | —       | JGS4175FAG              | —          | —       |
| 200                        | 1000-2000 | JGS2200FAG | JGS3200FAG              | JGS3200AAG | 160-200 | JGS4200FAG              | JGS4200AAG | 160-200 |
| 225                        | 1125-2250 | JGS2225FAG | JGS3225FAG              | —          | —       | JGS4225FAG              | —          | —       |
| 250                        | 1250-2500 | JGS2250FAG | JGS3250FAG              | JGS3250AAG | 200-250 | JGS4250FAG              | JGS4250AAG | 200-250 |
| 250                        | 1250-2500 | ③          | JGS3250KSG              | —          | —       | JGS4250KSG              | —          | —       |

| <b>IEC/CE/UL/CSA 70/65</b> |           |            |                         |            |         |                         |            |         |
|----------------------------|-----------|------------|-------------------------|------------|---------|-------------------------|------------|---------|
| 63                         | 315-630   | —          | JGH3063FAG <sup>②</sup> | JGH3063AAG | 40-63   | JGH4063FAG <sup>②</sup> | JGH4063AAG | 40-63   |
| 70                         | 350-700   | JGH2070FAG | JGH3070FAG              | —          | —       | JGH4070FAG              | —          | —       |
| 90                         | 450-900   | JGH2090FAG | JGH3090FAG              | —          | —       | JGH4090FAG              | —          | —       |
| 100                        | 500-1000  | JGH2100FAG | JGH3100FAG              | JGH3100AAG | 63-100  | JGH4100FAG              | JGH4100AAG | 63-100  |
| 125                        | 625-1250  | JGH2125FAG | JGH3125FAG              | JGH3125AAG | 100-125 | JGH4125FAG              | JGH4125AAG | 100-125 |
| 150                        | 750-1500  | JGH2150FAG | JGH3150FAG              | —          | —       | JGH4150FAG              | —          | —       |
| 160                        | 800-1600  | —          | JGH3160FAG <sup>②</sup> | JGH3160AAG | 125-160 | JGH4160FAG <sup>②</sup> | JGH4160AAG | 125-160 |
| 175                        | 875-1750  | JGH2175FAG | JGH3175FAG              | —          | —       | JGH4175FAG              | —          | —       |
| 200                        | 1000-2000 | JGH2200FAG | JGH3200FAG              | JGH3200AAG | 160-200 | JGH4200FAG              | JGH4200AAG | 160-200 |
| 225                        | 1125-2250 | JGH2225FAG | JGH3225FAG              | —          | —       | JGH4225FAG              | —          | —       |
| 250                        | 1250-2500 | JGH2250FAG | JGH3250FAG              | JGH3250AAG | 200-250 | JGH4250FAG              | JGH4250AAG | 200-250 |
| 250                        | 1250-2500 | ③          | JGH3250KSG              | —          | —       | JGH4250KSG              | —          | —       |

#### Components Frame

| <b>IEC/CE/UL/CSA 25/25</b> |   |           |           |   |   |           |   |   |
|----------------------------|---|-----------|-----------|---|---|-----------|---|---|
| 250                        | — | JGE2250NN | JGE3250NN | — | — | JGE4250NN | — | — |
| <b>IEC/CE/UL/CSA 40/35</b> |   |           |           |   |   |           |   |   |
| 250                        | — | JGS2250NN | JGS3250NN | — | — | JGS4250NN | — | — |
| <b>IEC/CE/UL/CSA 70/65</b> |   |           |           |   |   |           |   |   |
| 250                        | — | JGH2250NN | JGH3250NN | — | — | JGH4250NN | — | — |

#### Trip Unit

|     |           |                       |                       |                       |         |                       |                       |         |
|-----|-----------|-----------------------|-----------------------|-----------------------|---------|-----------------------|-----------------------|---------|
| 63  | 315-630   | JT2063FA <sup>②</sup> | JT3063FA <sup>②</sup> | JT3063AA <sup>②</sup> | 40-63   | JT4063FA <sup>②</sup> | JT4063AA <sup>②</sup> | 40-63   |
| 70  | 350-700   | JT2070FA              | JT3070FA              | —                     | —       | JT4070FA              | —                     | —       |
| 90  | 450-900   | JT2090FA              | JT3090FA              | —                     | —       | JT4090FA              | —                     | —       |
| 100 | 500-1000  | JT2100FA              | JT3100FA              | JT3100AA <sup>②</sup> | 63-100  | JT4100FA              | JT4100AA <sup>②</sup> | 63-100  |
| 125 | 625-1250  | JT2125FA              | JT3125FA              | JT3125AA <sup>②</sup> | 100-125 | JT4125FA              | JT4125AA <sup>②</sup> | 100-125 |
| 150 | 750-1500  | JT2150FA              | JT3150FA              | —                     | —       | JT4150FA              | —                     | —       |
| 160 | 800-1600  | JT2160FA <sup>②</sup> | JT3160FA <sup>②</sup> | JT3160AA <sup>②</sup> | 125-160 | JT4160FA <sup>②</sup> | JT4160AA <sup>②</sup> | 125-160 |
| 175 | 875-1750  | JT2175FA              | JT3175FA              | —                     | —       | JT4175FA              | —                     | —       |
| 200 | 1000-2000 | JT2200FA              | JT3200FA              | JT3200AA <sup>②</sup> | 160-200 | JT4200FA              | JT4200AA <sup>②</sup> | 160-200 |
| 225 | 1125-2250 | JT2225FA              | JT3225FA              | —                     | —       | JT4225FA              | —                     | —       |
| 250 | 1250-2500 | JT2250FA              | JT3250FA              | JT3250AA <sup>②</sup> | 200-250 | JT4250FA              | JT4250AA <sup>②</sup> | 200-250 |

① Change the 4th digit to 8 for adjustable 0-60% neutral protection, 9 for 0-100% neutral protection.

② IEC-EN 60947-2 only.

③ Use 3-pole MCS.



### Selection Guide and Ordering Information

#### Line and Load Terminals

J250-Frame circuit breakers include Cu terminals, T250FJ as standard. When optional copper or Cu/Al terminals are required, order by catalogue number.

| Maximum Breaker Amperes                                  | Terminal Body Material | Wire Type | Metric Wire Range mm <sup>2</sup> | AWG Wire Range/ Number Conductors | Catalogue Number |
|--|------------------------|-----------|-----------------------------------|-----------------------------------|------------------|
| <b>Standard Pressure Type Terminals</b>                  |                        |           |                                   |                                   |                  |
| 250  | Stainless Steel        | Cu        | 25-185                            | 4-350/(1)                         | T250FJ①②         |
| 250  | Aluminium              | Cu/Al     | 25-185                            | 4-350/(1)                         | TA250FJ①         |
| <b>Optional Copper and Cu/Al Pressure Type Terminals</b> |                        |           |                                   |                                   |                  |
| 250  | Copper                 | Cu/Al     | 25-185                            | 4-350/(1)                         | TC250FJ①         |

#### Catalogue Number

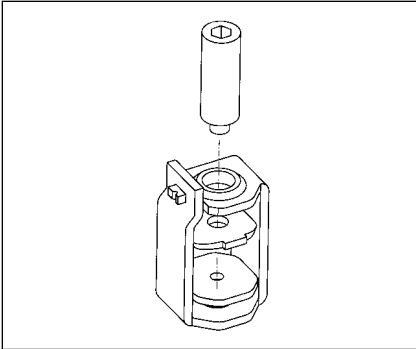

T250FJ

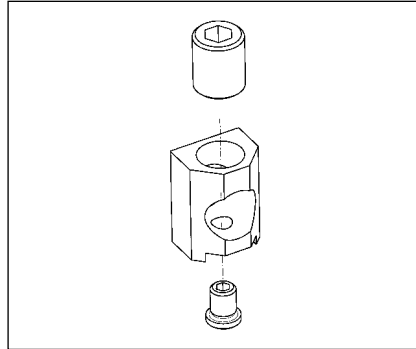

TA250FJ

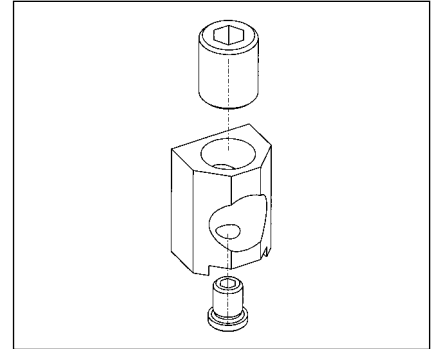

TC250FJ

#### Endcap Kit

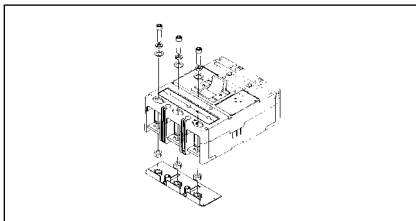

Endcap kits are used on J250 Frame breaker line load to connect bus bar or similar electrical connections. Includes hardware.

#### Kit Catalogue Number

| Number of Poles | Catalogue Number |          |
|-----------------|------------------|----------|
|                 | Metric           | Imperial |
| 3               | FJ3RTWK          | FJ3RTDK  |
| 4               | FJ4RTWK          | FJ4RTDK  |

#### Control Wire Terminal Kit

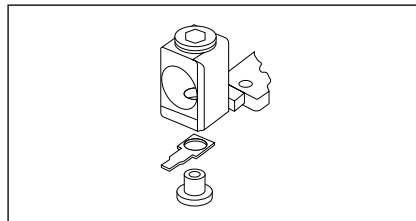

For use with aluminium or copper terminals only.

|                                     |
|-------------------------------------|
| Package of 14 - Priced Individually |
| Catalogue Number – FJCWTK           |

#### Base Mounting Hardware

Base mounting hardware is included with a circuit breaker or moulded case switch. (Included with breaker).

#### Terminal Shields IP30

| Location     | Number of Poles | Catalogue Number<br>Package of 10 |
|--------------|-----------------|-----------------------------------|
| Line or Load | 2, 3<br>4       | FJTS3K<br>FJTS4K                  |

#### Interphase Barriers

| Package of 2    |                  |
|-----------------|------------------|
| Number of Poles | Catalogue Number |
| 3               | FJIPBK           |
| 4               | FJIPBK4          |

① Individually packed.  
② Standard line and load terminals.

**Cutler-Hammer Frame Size K, 63-400 Amperes**

**Selection Guide and Ordering Information**

| Maximum Continuous Ampere Rating at 40°C <sup>①②</sup> | Number of Poles | Thermal Range | Magnetic Range | Standard Interrupting Capacity Catalogue Number   |            | High Interrupting Capacity Catalogue Number   |            | Ultra-High Interrupting Capacity Catalogue Number   |            | Thermal Magnetic Trip Unit Only                                | Standard Terminals Only Catalogue Number | Metric Mounting Hardware Catalogue Number |
|--|-----------------|---------------|----------------|---|------------|---|------------|---|------------|--|--|---|
|  |                 |               |                | U <sub>e</sub> Max. 690 VAC   |            | U <sub>e</sub> Max. 690 VAC   |            | U <sub>e</sub> Max. 690 VAC   |            |  |  |   |
|  |                 |               |                | 45 kA I <sub>cu</sub> at 415 VAC  |            | 70 kA I <sub>cu</sub> at 415 VAC  |            | 100 kA I <sub>cu</sub> at 415 VAC   |            |  |  |   |
|  |                 |               |                | Factory Assembled Circuit Breaker Consisting of Frame, Trip Unit, and Terminals and Mounting Hardware | Frame Only | Factory Assembled Circuit Breaker Consisting of Frame, Trip Unit, and Terminals and Mounting Hardware | Frame Only | Factory Assembled Circuit Breaker Consisting of Frame, Trip Unit, and Terminals and Mounting Hardware | Frame Only |  |  |   |
|  |                 |               |                |   |            |   |            |   |            | For Use with Standard or High or Ultra-High Interrupting Frame |  |   |
|  |                 |               |                |   |            |   |            |   |            | Adjustable Thermal   |  |   |
|  |                 |               |                |   |            |   |            |   |            | Adjustable Magnetic  |  |   |

**Adjustable Thermal Magnetic Circuit Breakers with Interchangeable Trip Units**

|                          |        |  |  | Type KW  |         | Type HKW   |          | Type KWC   |          |  |  |                                  |
|--------------------------|--------|--|--|--|---------|--|----------|--|----------|--|--|----------------------------------|
| 200<br>250<br>315<br>400 | 2-Pole | 160-200<br>200-250<br>250-315<br>315-400 | 1000-2000<br>1250-2500<br>1575-3150<br>2000-4000 | KW2200<br>KW2250<br>KW2315<br>KW2400   | KW2400F | HKW2200<br>HKW2250<br>HKW2315<br>HKW2400   | HKW240F  | KWC2200<br>KWC2250<br>KWC2315<br>KWC2400   | KWC2400F | KT2200TA<br>KT2250TA<br>KT2315TA<br>KT2400TA   | TA300KM <sup>①</sup><br>TA300KM <sup>①</sup><br>TA350KM <sup>①</sup><br>TA350KM <sup>①</sup> | BMH3M<br>BMH3M<br>BMH3M<br>BMH3M |
| 200<br>250<br>315<br>400 | 3-Pole | 160-200<br>200-250<br>250-315<br>315-400 | 1000-2000<br>1250-2500<br>1575-3150<br>2000-4000 | KW3200<br>KW3250<br>KW3315<br>KW3400   | KW3400F | HKW3200<br>HKW3250<br>HKW3315<br>HKW3400   | HKW3400F | KWC3200<br>KWC3250<br>KWC3315<br>KWC3400   | KWC3400F | KT3200TA<br>KT3250TA<br>KT3315TA<br>KT3400TA   | TA300KM <sup>①</sup><br>TA300KM <sup>①</sup><br>TA350KM <sup>①</sup><br>TA350KM <sup>①</sup> | BMH3M<br>BMH3M<br>BMH3M<br>BMH3M |
| 200<br>250<br>315<br>400 | 4-Pole | 160-200<br>200-250<br>250-315<br>315-400 | 1000-2000<br>1250-2500<br>1575-3150<br>2000-4000 | KW4200<br>KW4250<br>KW4315<br>KW4400<br>KW4315E <sup>③</sup><br>KW4400E <sup>③</sup> | KW4400F | HKW4200<br>HKW4250<br>HKW4315<br>HKW4400<br>HKW4315E <sup>③</sup><br>HKW4400E <sup>③</sup> | HKW4400F | KWC4200<br>KWC4250<br>KWC4315<br>KWC4400<br>KWC4315E <sup>③</sup><br>KWC4400E <sup>③</sup> | KWC4400F | KT4200TA<br>KT4250TA<br>KT4315TA<br>KT4400TA<br>KT4315TEA <sup>③</sup><br>KT4400TEA <sup>③</sup> | TA300KM <sup>①</sup><br>TA300KM <sup>①</sup><br>TA350KM <sup>①</sup><br>TA350KM <sup>①</sup> | BMH3M<br>BMH3M<br>BMH3M<br>BMH3M |

**Adjustable Thermal Magnetic Earth Leakage Circuit Breakers with Line and Load Terminals Included**

|                          |        |  |  | Type ELKW (U <sub>e</sub> Max. 415 VAC)      |   | Type ELHKW (U <sub>e</sub> Max. 415 VAC)         |   | Type ELKWC (U <sub>e</sub> Max. 415 VAC)         |   |   |  |                                  |
|--------------------------|--------|--|--|--|---|--|---|--|---|---|--|----------------------------------|
| 200<br>250<br>315<br>400 | 3-Pole | 160-200<br>200-250<br>250-315<br>315-400 | 1000-2000<br>1250-2500<br>1575-3150<br>2000-4000 | ELKW3200<br>ELKW3250<br>ELKW3315<br>ELKW3400 | - | ELHKW3200<br>ELHKW3250<br>ELHKW3315<br>ELHKW3400 | - | ELKWC3200<br>ELKWC3250<br>ELKWC3315<br>ELKWC3400 | - | - | TA350KM<br>TA350KM<br>TA350KM<br>TA350KM | BMH3M<br>BMH3M<br>BMH3M<br>BMH3M |
| 200<br>250<br>315<br>400 | 4-Pole | 160-200<br>200-250<br>250-315<br>315-400 | 1000-2000<br>1250-2500<br>1575-3150<br>2000-4000 | ELKW4200<br>ELKW4250<br>ELKW4315<br>ELKW4400 | - | ELHKW4200<br>ELHKW4250<br>ELHKW4315<br>ELHKW4400 | - | ELKWC4200<br>ELKWC4250<br>ELKWC4315<br>ELKWC4400 | - | - | TA350KM<br>TA350KM<br>TA350KM<br>TA350KM | BMH3M<br>BMH3M<br>BMH3M<br>BMH3M |

**Moulded Case Switches MCS Only without Line and Load Terminals**

|     |                            |   |   | Type KW (U <sub>e</sub> Max. 690 VAC) |   | Type HKW (U <sub>e</sub> Max. 690 VAC) |   |   |   |   |   |  |                         |
|-----|----------------------------|---|---|---------------------------------------|---|--|---|---|---|---|---|--|-------------------------|
| 400 | 2-Pole<br>3-Pole<br>4-Pole | - | - | KW2400KW<br>KW3400KW<br>KW4400KW      | - | HKW2400KW<br>HKW3400KW<br>HKW4400KW    | - | - | - | - | - | TA350KM <sup>①</sup><br>TA350KM <sup>①</sup><br>TA350KM <sup>①</sup> | BMH3M<br>BMH3M<br>BMH3M |

**Electronic Circuit Breakers<sup>④</sup>**

**With Interchangeable Type KES Digitrip RMS Trip Units – Order as Individual Components: Breaker Frame, Trip Unit, Rating Plug, Terminals, Mounting Hardware**

| Maximum Continuous Ampere Rating at 40°C <sup>①②</sup> | Number of Poles | Circuit Breaker Frame Only Catalogue Number |                                  |                                   | Digitrip RMS 310 Trip Unit Only Less Rating Plug Catalogue Number   |            |            |             | Digitrip RMS 310 Only Rating Plug Order as Individual Component |  |  | Standard Terminals Only Catalogue Number   | Metric Mounting Hardware Catalogue Number |                  |
|--|-----------------|---|----------------------------------|-----------------------------------|---|------------|------------|-------------|---|--|--|--|---|------------------|
|  |                 | Standard Interrupting Capacity              | High Interrupting Capacity       | Ultra-High Interrupting Capacity  | L - Adjustable Long Delay Pickup (By Adjustable Rating Plug)<br>S - Adjustable Short Delay Pickup with Fixed Short Delay Time (I <sup>2</sup> t Response) or Adjustable Short Delay Time (Flat Response)<br>I - Adjustable Instantaneous Pickup by Setting Short Delay Time to Instantaneous<br>G - Adjustable Ground Fault Pickup with Adjustable Ground Fault Delay (Flat Response) |            |            |             | Fixed Rating Plug   |  | Adjustable Rating Plug                                 |  |   |                  |
|  |                 | U <sub>e</sub> Max. 690 VAC                 |                                  |                                   | LS  | LSI        | LSG        | LSIG        | Ampere Rating   | Catalogue Number   | Ampere Rating  |  |   | Catalogue Number |
|  |                 | 45 kA I <sub>cu</sub> at 415 VAC            | 70 kA I <sub>cu</sub> at 415 VAC | 100 kA I <sub>cu</sub> at 415 VAC |   |            |            |             |   |  |  |  |   |                  |
| 125  | 3-Pole          | KW3400F                                     | HKW3400F                         | KWC3400F                          | KES3125LS   | KES3125LSI | KES3125LSG | KES3125LSIG | 63<br>70<br>90<br>100<br>125                                    | 1KES063T<br>1KES070T<br>1KES090T<br>1KES100T<br>1KES125T | Adjustable Settings are: 63/80/100/125<br>A1KES125T2   | TA300KM <sup>①</sup><br>TA300KM <sup>①</sup><br>TA300KM <sup>①</sup><br>TA300KM <sup>①</sup><br>TA300KM <sup>①</sup> | BMH3M<br>BMH3M<br>BMH3M<br>BMH3M<br>BMH3M |                  |
| 250  |                 | KW3400F                                     | HKW3400F                         | KWC3400F                          | KES3250LS   | KES3250LSI | KES3250LSG | KES3250LSIG | 125<br>160<br>200<br>225<br>250                                 | 2KES125T<br>2KES160T<br>2KES200T<br>2KES225T<br>2KES250T | Adjustable Settings are: 125/160/225/250<br>A2KES250T2 | TA300KM <sup>①</sup><br>TA300KM <sup>①</sup><br>TA300KM <sup>①</sup><br>TA300KM <sup>①</sup><br>TA300KM <sup>①</sup> | BMH3M<br>BMH3M<br>BMH3M<br>BMH3M<br>BMH3M |                  |
| 400  |                 | KW3400F                                     | HKW3400F                         | KWC3400F                          | KES3400LS   | KES3400LSI | KES3400LSG | KES3400LSIG | 200<br>225<br>250<br>315<br>400                                 | 4KES200T<br>4KES225T<br>4KES250T<br>4KES315T<br>4KES400T | Adjustable Settings are: 200/250/315/400<br>A4KES400T2 | TA300KM <sup>①</sup><br>TA300KM <sup>①</sup><br>TA300KM <sup>①</sup><br>TA350KM <sup>①</sup><br>TA350KM <sup>①</sup> | BMH3M<br>BMH3M<br>BMH3M<br>BMH3M<br>BMH3M |                  |

① Individually packed.

② Special 50°C rating available. Order by description.

③ 60% protected neutral - left pole

④ For AC application only.

Selection Guide and Ordering Information

Line and Load Terminals

K-Frame circuit breakers include Cu/Al terminals as standard. When optional copper or Cu/1919Al terminals are required, order by catalogue number.

| Maximum Breaker Amperes                                  | Terminal Body Material | Wire Type | Metric Wire Range mm <sup>2</sup> | AWG Wire Range/ Number Conductors | Catalogue Number   |
|--|------------------------|-----------|-----------------------------------|-----------------------------------|--|
| <b>Standard Pressure Type Terminals</b>                  |                        |           |                                   |                                   |  |
| 225  | Aluminium              | Cu/Al     | 35-185                            | 3-350/(1)                         | TA300KM <sup>①③</sup>  |
| 400  | Aluminium              | Cu/Al     | 120-240                           | 250-500/(1)                       | TA350KM <sup>①③⑤</sup>   |
| <b>Optional Copper and Cu/Al Pressure Type Terminals</b> |                        |           |                                   |                                   |  |
| 225  | Copper                 | Cu        | 35-185                            | 3-350/(1)                         | T300K <sup>②③</sup>  |
| 400  | Copper                 | Cu        | 120-240                           | 250-500/(1)                       | T300K <sup>②③</sup>  |
| 400  | Aluminium              | Cu/Al     | 95-120                            | 3/0-250/(2)                       | 2TA400K - 2-Pole Kit <sup>②④</sup><br>3TA400K - 3-Pole Kit <sup>②④</sup><br>4TA400K - 4-Pole Kit <sup>②④</sup> |
| 400  | Aluminium              | Cu        | 95-120                            | 3/0-250/(2)                       | 2T400K - 2-Pole Kit <sup>②④</sup><br>3T400K - 3-Pole Kit <sup>②④</sup><br>4T400K - 4-Pole Kit <sup>②④</sup>    |
| 400  | Aluminium              | Cu/Al     | 70-240<br>70-240<br>70-240        | 2/0-250/(2)<br>or<br>2/0-500/(1)  | 2TA401K - 2-Pole Kit <sup>②④</sup><br>3TA401K - 3-Pole Kit <sup>②④</sup><br>4TA401K - 4-Pole Kit <sup>②④</sup> |

Catalogue Number

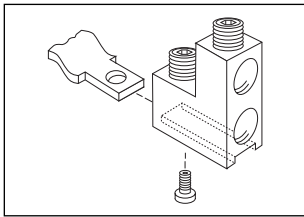

TA300KM, TA300K, T300K

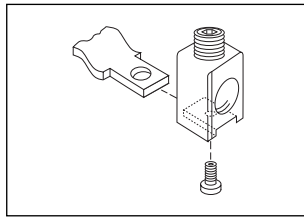

TA350KM, TA350K, T350K

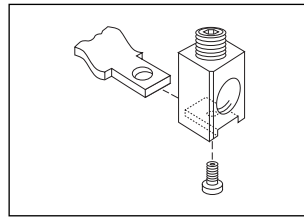

TA400K, T400K

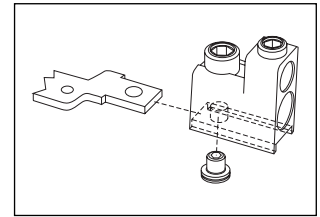

TA401K

Endcap Kit

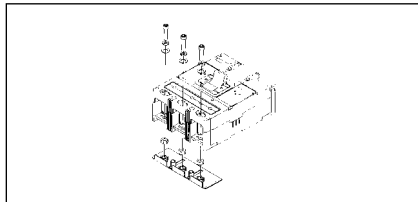

Endcap kits are used on K-Frame breaker line load to connect bus bar or similar electrical connections. Includes hardware.

Kit Catalogue Number

| Metric | Imperial |
|--------|----------|
| KPEKM3 | KPEK3    |

Control Wire Terminal Kit

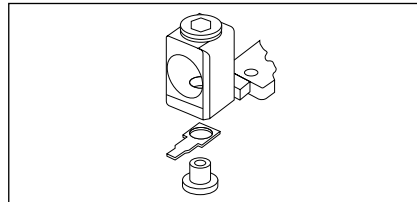

For use with aluminium or copper terminals only.

|                                     |
|-------------------------------------|
| Package of 14 - Priced Individually |
| Catalogue Number - KCWTK            |

Base Mounting Hardware

Base mounting hardware is included with a circuit breaker or moulded case switch.

| Number of Poles        | Description   | Type of Mounting | Catalogue Number |
|------------------------|---|------------------|------------------|
| <b>Metric Thread</b>   |   |                  |                  |
| 2, 3, 4                | M6-0.7 x 38 mm Pan-Head Setscrews and Lockwashers         | Individual       | 4218B80G14       |
| <b>Imperial Thread</b> |   |                  |                  |
| 2, 3, 4                | 0.250-20 x 1.5 Inch Pan-Head Steel Screws and Lockwashers | Individual       | 4218B80G14       |

Handle Extension

Not included with breaker. Must be purchased separately.

|                         |
|-------------------------|
| Packaged Individually   |
| Catalogue Number - HEX3 |

Terminal Shields

| Location | Number of Poles | Catalogue Number Package of 10 |
|----------|-----------------|--------------------------------|
| Line End | 2, 3<br>4       | TS33LN<br>TS34LN               |
| Load End | 3               | TS33LD                         |

Interphase Barriers

|                         |
|-------------------------|
| Package of 2            |
| Catalogue Number - IPB3 |

- ① Metric hardware.
- ② Imperial hardware.
- ③ Individually packed.
- ④ TA400K, T400K, and TA401K terminal kits contain one terminal for each pole and one terminal cover.
- ⑤ Standard terminal.

Cutler-Hammer Frame Size L, 315-800 Amperes

**Selection Guide and Ordering Information**

| Maximum Continuous Ampere Rating at 40°C <sup>①②</sup>                          | Number of Poles | Standard Interrupting Capacity Catalogue Number |  | High Interrupting Capacity Catalogue Number                                     |  | Ultra-High Interrupting Capacity Catalogue Number |  | Thermal Magnetic Trip Unit Only<br>For Use with Standard or High or Ultra-High Interrupting Frame<br>Adjustable Thermal<br>Adjustable Magnetic | Standard Terminals Only Catalogue Number | Metric Mounting Hardware Catalogue Number |
|---|-----------------|---|--|---|--|---|--|--|--|---|
|   |                 | U <sub>e</sub> Max. 690 VAC                     |  | U <sub>e</sub> Max. 690 VAC   |  | U <sub>e</sub> Max. 690 VAC                       |  |  |  |   |
|   |                 | 45 kA I <sub>cu</sub> at 415 VAC                |  | 70 kA I <sub>cu</sub> at 415 VAC  |  | 100 kA I <sub>cu</sub> at 415 VAC                 |  |  |  |   |
| Factory Assembled Circuit Breaker Consisting of Frame, Trip Unit, and Terminals |                 | Frame Only                                      |  | Factory Assembled Circuit Breaker Consisting of Frame, Trip Unit, and Terminals |  | Frame Only  |  |  |  |   |

**Adjustable Thermal Magnetic Circuit Breakers with Interchangeable Trip Units**

| -                        |        | Type LW   |         | Type HLW  |          | Type LWC  |          | -   |   |                                  |
|--------------------------|--------|---|---------|---|----------|---|----------|---|---|----------------------------------|
| 315<br>400<br>500<br>630 | 2-Pole | LW2315<br>LW2400<br>LW2500<br>LW2630                              | LW2630F | HLW2315<br>HLW2400<br>HLW2500<br>HLW2630                  | HLW2630F | LWC2315<br>LWC2400<br>LWC2500<br>LWC2630                  | LWC2630F | LT2315TA<br>LT2400TA<br>LT2500TA<br>LT2630TA                | TA602LDM <sup>①</sup><br>TA602LDM <sup>①</sup><br>TA602LDM <sup>①</sup><br>TA603LDKM <sup>③</sup> | BMH4M<br>BMH4M<br>BMH4M<br>BMH4M |
| 315<br>400<br>500<br>630 | 3-Pole | LW3315<br>LW3400<br>LW3500<br>LW3630                              | LW3630F | HLW3315<br>HLW3400<br>HLW3500<br>HLW3630                  | HLW3630F | LWC3315<br>LWC3400<br>LWC3500<br>LWC3630                  | LWC3630F | LT3315TA<br>LT3400TA<br>LT3500TA<br>LT3630TA                | TA602LDM <sup>①</sup><br>TA602LDM <sup>①</sup><br>TA602LDM <sup>①</sup><br>TA603LDKM <sup>③</sup> | BMH4M<br>BMH4M<br>BMH4M<br>BMH4M |
| 315<br>400<br>500<br>630 | 4-Pole | LW4315 <sup>③</sup><br>LW4400 <sup>③</sup><br>LW4500 <sup>③</sup> | LW4630F | HLW4315<br>HLW4400<br>HLW4500                             | HLW4630F | LWC4315<br>LWC4400<br>LWC4500                             | LWC4630F | LT4315TA<br>LT4400TA<br>LT4500TA                            | TA602LDM <sup>①</sup><br>TA602LDM <sup>①</sup><br>TA602LDM <sup>①</sup>                           | BMH4M<br>BMH4M<br>BMH4M          |
| 630<br>500<br>630        |        | LW4630 <sup>③</sup><br>LW4500 <sup>④</sup><br>LW4630 <sup>④</sup> |         | HLW4630<br>HLW4500E <sup>④</sup><br>HLW4630E <sup>④</sup> |          | LWC4630<br>LWC4500E <sup>④</sup><br>LWC4630E <sup>④</sup> |          | LT4630TA<br>LT4500TA <sup>④</sup><br>LT4630TAE <sup>④</sup> | TA603LDKM <sup>③</sup><br>TA602LDM <sup>①</sup><br>TA603LDKM <sup>③</sup>                         | BMH4M<br>BMH4M<br>BMH4M          |

**Thermal Magnetic Fixed Thermal Circuit Breakers with Noninterchangeable Trip Units and Bus Extension**

| -          |        | Types LW (U <sub>e</sub> Max. 690 VAC, 50 kA I <sub>cu</sub> @ 415 VAC) |   | - |   |   |   |   |   |   |                |
|------------|--------|---|---|---|---|---|---|---|---|---|----------------|
| 700<br>800 | 3-Pole | LW3700W<br>LW3800W  | - | - | - | - | - | - | - | - | BMH4M<br>BMH4M |

**Moulded Case Switches MCS Only without Line and Load Terminals**

| -   |                            | Type LW (690 VAC Max.)           |   | Type HLW (690 VAC Max.)             |   | - |   |   |   |  |                         |
|-----|----------------------------|----------------------------------|---|-------------------------------------|---|---|---|---|---|--|-------------------------|
| 630 | 2-Pole<br>3-Pole<br>4-Pole | LW2630KW<br>LW3630WK<br>LW4630WK | - | HLW2630KW<br>HLW3630WK<br>HLW4630WK | - | - | - | - | - | TA603LDKM <sup>③</sup><br>TA603LDKM <sup>③</sup><br>TA603LDKM <sup>③</sup> | BMH4M<br>BMH4M<br>BMH4M |
| 800 | 3-Pole<br>4-Pole           | LW3800WK<br>LW4800WK             | - | -                                   | - | - | - | - | - | -  | BMH4M<br>BMH4M          |

**Electronic Circuit Breakers<sup>⑥</sup>**

With Interchangeable Type LES Digitrip RMS Trip Units – Order as Individual Components: Breaker Frame, Trip Unit, Rating Plug, Terminals, Mounting Hardware

| Maximum Continuous Ampere Rating at 40°C <sup>①②</sup> | Number of Poles     | Circuit Breaker Frame Only Catalogue Number |                                  |                                   | Digitrip RMS 310 Trip Unit Only Less Rating Plug Catalogue Number <sup>⑤</sup>  |            |            |             | Digitrip RMS 310 Only Rating Plug Order as Individual Component |  |  | Standard Terminals Only Catalogue Number  | Metric Mounting Hardware Catalogue Number |  |
|--|---------------------|---|----------------------------------|-----------------------------------|---|------------|------------|-------------|---|--|--|---|---|--|
|  |                     | Standard Interrupting Capacity              | High Interrupting Capacity       | Ultra-High Interrupting Capacity  | L - Adjustable Long Delay Pickup (By Adjustable Rating Plug)<br>S - Adjustable Short Delay Pickup with Fixed Short Delay Time (I <sup>2</sup> t Response) or Adjustable Short Delay Time (Flat Response)<br>I - Adjustable Instantaneous Pickup by Setting Short Delay Time to Instantaneous<br>G - Adjustable Ground Fault Pickup with Adjustable Ground Fault Delay (Flat Response) |            |            |             | Fixed Rating Plug   |  | Adjustable Rating Plug                                 |   |   |  |
|  |                     | 660 VAC Max.                                |                                  |                                   | LS  | LSI        | LSG        | LSIG        | Ampere Rating   | Catalogue Number   | Ampere Rating Catalogue Number                         |   |   |  |
|  |                     | 45 kA I <sub>cu</sub> at 415 VAC            | 70 kA I <sub>cu</sub> at 415 VAC | 100 kA I <sub>cu</sub> at 415 VAC | Type LW   |            | Type HLW   | Type LWC    |   |  |  |   |   |  |
| 630  | 3-Pole <sup>⑦</sup> | LW3630F                                     | HLW3630F                         | LWC3630F                          | LES3630LS   | LES3630LSI | LES3630LSG | LES3630LSIG | 315<br>350<br>400<br>500<br>630                                 | 6LES315T<br>6LES350T<br>6LES400T<br>6LES500T<br>6LES630T | Adjustable Settings are: 315/400/500/630<br>A6LES630T2 | TA602LDM <sup>①</sup><br>TA602LDM <sup>①</sup><br>TA602LDM <sup>①</sup><br>TA603LDKM <sup>③</sup><br>TA603LDKM <sup>③</sup> | BMH4M<br>BMH4M<br>BMH4M<br>BMH4M<br>BMH4M |  |
|  | 4-Pole <sup>⑧</sup> | LW4630F                                     | HLW4630F                         | LWC4630F                          | LES4630LS   | LES4630LSI | LES4630LSG | LES4630LSIG | 315<br>350<br>400<br>500<br>630                                 | 6LES315T<br>6LES350T<br>6LES400T<br>6LES500T<br>6LES630T | Adjustable Settings are: 315/400/500/630<br>A6LES630T2 | TA602LDM <sup>①</sup><br>TA602LDM <sup>①</sup><br>TA602LDM <sup>①</sup><br>TA603LDKM <sup>③</sup><br>TA603LDKM <sup>③</sup> | BMH4M<br>BMH4M<br>BMH4M<br>BMH4M<br>BMH4M |  |

**Electronic Circuit Breakers**

Includes Circuit Breaker Frame, Digitrip RMS 310 Electronic Trip Units with Noninterchangeable Adjustable Rating Plug and Bus Extension

|     |                     |   |   |   |   |   |   |   |   |   |  |   |                         |
|-----|---------------------|---|---|---|---|---|---|---|---|---|--|---|-------------------------|
| 800 | 3-Pole <sup>⑦</sup> | LW3800T33W<br>LW3800T35W<br>LW3800T35XW | - | - | - | - | - | - | - | - | Adjustable Settings are: 400/500/630/800<br>A8LES800T1 | - | BMH4M<br>BMH4M<br>BMH4M |
|     | 4-Pole <sup>⑧</sup> | LW4800T33W                              | - | - | - | - | - | - | - | - | -  | - | BMH4M                   |

① Individually packed.  
② Special 50°C rating available. Order by description.  
③ 2TA603KM, 3TA603LDKM and 4TA603LDKM terminal kits contain one terminal per each pole and one terminal cover.

④ 60% protected neutral – left pole  
⑤ Ampere rating is established by rating plug.  
⑥ For AC application only.  
⑦ 3-pole LES trip units are for use in 3-pole frames only.

⑧ Trip unit includes unprotected left neutral pole. For 100% protected left pole neutral add "P" to catalogue number, i.e., LES4630LSP.

Cutler-Hammer Frame Size L, 315-800 Amperes

Selection Guide and Ordering Information

Line and Load Terminals

L-Frame circuit breakers include Cu/Al terminals as standard equipment. When optional copper terminals are required, order by catalogue number. 800 ampere L-Frame circuit breakers include bus extensions only.

| Maximum Breaker Amperes                        | Terminal Body Material | Wire Type | Metric Wire Range mm <sup>2</sup> | AWG Wire Range / No. Conductors | Catalogue Number   |
|--|------------------------|-----------|-----------------------------------|---------------------------------|--|
| <b>Standard Cu/Al Pressure Type Terminals</b>  |                        |           |                                   |                                 |  |
| 400  | Aluminium              | Cu/Al     | 120-300                           | 4/0-600 (1)                     | 3TA401LDKM - 3-Pole Kit <sup>②</sup><br>4TA401LDKM - 4-Pole Kit <sup>②</sup> |
| 450  | Aluminium              | Cu/Al     | 25-95 (2)                         | 4-4/0 (2)                       | TA450LDM <sup>①</sup>  |
| 500  | Aluminium              | Cu/Al     | 120-150                           | 250-350 (2)                     | TA602LDM <sup>①</sup>  |
| 600  | Aluminium              | Cu/Al     | 185-240 (2)                       | 400-500 (2)                     | 3TA603LDKM - 3-Pole Kit <sup>②</sup><br>4TA603LDKM - 4-Pole Kit <sup>②</sup> |
| <b>Optional Copper Pressure Type Terminals</b> |                        |           |                                   |                                 |  |
| 600  | Copper                 | Copper    | 120-150                           | 250-350 (2)                     | T602LDM <sup>①</sup>   |

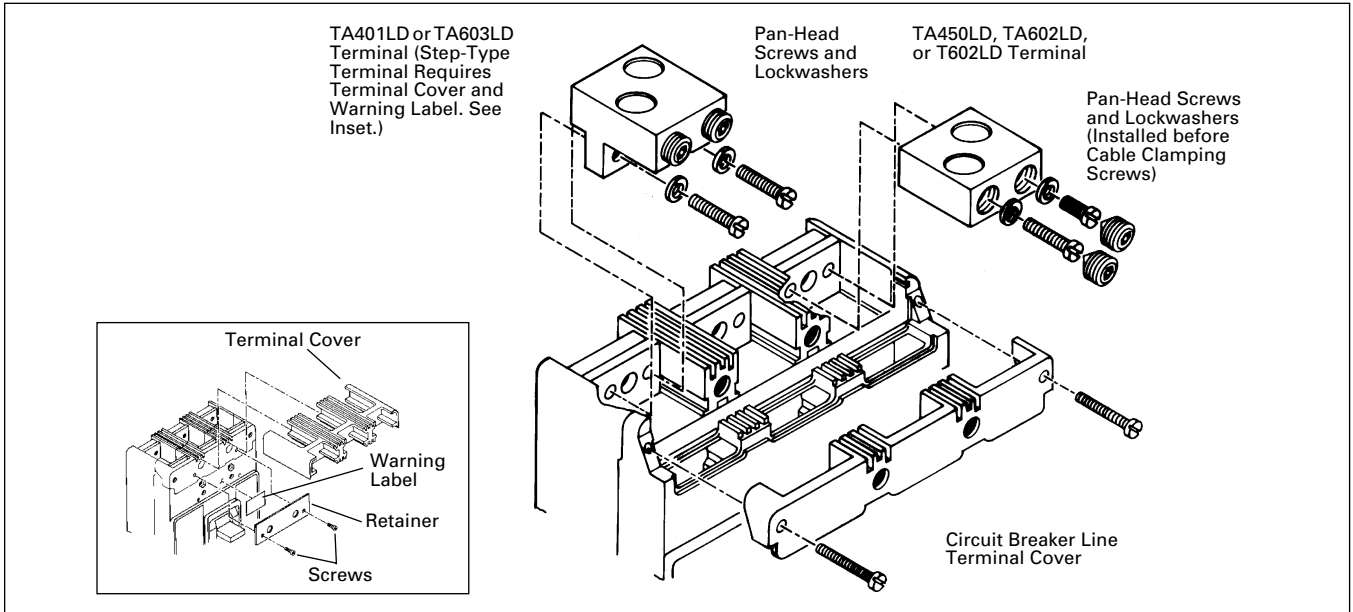

Terminal Shields

Terminal shields provide protection against accidental contact with live line side terminations. Terminal shields are fabricated from high dielectric insulating material and fasten over the front terminal access openings. Small openings in the shields provide limited access to the terminals for tightening connectors. (Field installation only.)

|                           |
|---------------------------|
| Package of 2              |
| Style Number – 314C420G01 |

Handle Extension

Not included with breaker. Must be purchased separately.

|                         |
|-------------------------|
| Packaged Individually   |
| Catalogue Number – HEX4 |

Keeper Nut

Not required on L-Frame. Terminal is threaded.

① Individually packed.  
② Terminal kits contain one terminal for each pole and one terminal cover.

Base Mounting Hardware

Base mounting hardware is included with a circuit breaker or moulded case switch.

| Number of Poles        | Description  | Type of Mounting | Style Number |
|------------------------|--|------------------|--------------|
| <b>Metric Thread</b>   |  |                  |              |
| 2, 3                   | 0.250-20 x   | Individual       | 5103A09G01   |
| <b>Imperial Thread</b> |  |                  |              |
| 2, 3, 4                | 0.250-20 x 1.5 Inch Filister-Head Steel Screws and Lock-washers and Flat Washers | Individual       | 21C6782G05   |

Kit Catalogue Number

| Metric | Imperial |
|--------|----------|
| KPEKM4 | KPEK4    |

Interphase Barriers

The interphase barriers provide additional electrical clearance between circuit breaker poles for special termination applications. The barriers are high dielectric insulating plates that are installed in the moulded slots

between the terminals. (Field installation only.) Two per package.

|                         |
|-------------------------|
| Package of 2            |
| Catalogue Number – IPB4 |

Endcap Kit

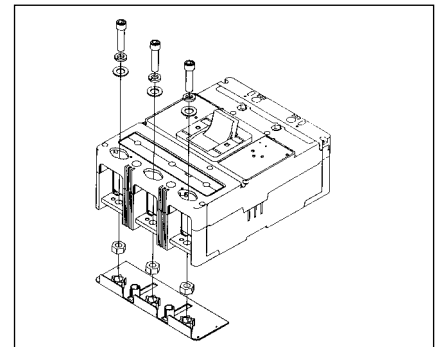

Endcap kits are used on L-Frame breaker line load to connect bus bar or similar electrical connections. Includes hardware.

Kit Catalogue Number

| Metric | Imperial |
|--------|----------|
| KPEKM4 | KPEK4    |

Cutler-Hammer Frame Size N, 400-1250 Amperes 50 kA at 415 VAC

### Selection Guide and Ordering Information

| Maximum Continuous Ampere Rating at 40°C <sup>①②</sup> | Number of Poles | Circuit Breaker Frame Including Digitrip RMS 310 Electronic Trip Unit Less Rating Plugs and Terminals<br>Order as Individual Component – Catalogue Number <sup>③</sup> |                      |                      |                      | Digitrip RMS 310 Interchangeable Rating Plugs<br>Order as Individual Component |                  |                                |
|--|-----------------|--|----------------------|----------------------|----------------------|--|------------------|--------------------------------|
|  |                 | LS   | LSI                  | LSG                  | LSIG                 | Fixed Rating Plug  |                  | Adjustable Rating Plug         |
|  |                 |  |                      |                      |                      | Ampere Rating  | Catalogue Number | Ampere Rating Catalogue Number |
|  |                 |  |                      |                      |                      |  |                  |                                |
| Short Time Range                                       |                 | 2-8 x I <sub>n</sub>   | 2-8 x I <sub>n</sub> | 2-8 x I <sub>n</sub> | 2-8 x I <sub>n</sub> |  |                  |                                |
| Short Time Delay                                       |                 | –  | 0-300 ms             | –                    | 0-300 ms             |  |                  |                                |
| Ground Fault Pickup                                    |                 | –  | –                    | 200-1200A            | 200-1200A            |  |                  |                                |
| Ground Fault Delay                                     |                 | –  | –                    | 0-500 ms             | 0-500 ms             |  |                  |                                |

Type NW Standard Interrupting Capacity – U<sub>e</sub> Max. 690 VAC, 50 kA I<sub>cu</sub> at 415 VAC

|      |        |            |            |            |            |   |   |  |
|------|--------|------------|------------|------------|------------|---|---|--|
| 800  | 2-Pole | NW2800T33W | NW2800T32W | NW2800T35W | NW2800T36W | 400<br>450<br>500<br>550<br>600<br>630<br>700<br>800    | 8NES400T<br>8NES450T<br>8NES500T<br>8NES550T<br>8NES600T<br>8NES630T<br>8NES700T<br>8NES800T            | Adjustable Settings Are:<br>400/500/630/800<br>8NES800T2 |
|      | 3-Pole | NW3800T33W | NW3800T32W | NW3800T35W | NW3800T36W | 400<br>450<br>500<br>550<br>600<br>630<br>700<br>800    | 8NES400T<br>8NES450T<br>8NES500T<br>8NES550T<br>8NES600T<br>8NES630T<br>8NES700T<br>8NES800T            | 400/500/630/800<br>8NES800T2                             |
|      | 4-Pole | NW4800T33W | NW4800T32W | –          | –          | 400<br>450<br>500<br>550<br>600<br>630<br>700<br>800    | 8NES400T<br>8NES450T<br>8NES500T<br>8NES550T<br>8NES600T<br>8NES630T<br>8NES700T<br>8NES800T            | 400/500/630/800<br>8NES800T2                             |
| 1250 | 2-Pole | NW2125T33W | NW2125T32W | NW2125T35W | NW2125T36W | 600<br>630<br>700<br>800<br>900<br>1000<br>1200<br>1250 | 12NES600T<br>12NES630T<br>12NES700T<br>12NES800T<br>12NES900T<br>12NES1000T<br>12NES1200T<br>12NES1250T | 630/800/1000/1250<br>A12NES1250T2                        |
|      | 3-Pole | NW3125T33W | NW3125T32W | NW3125T35W | NW3125T36W | 600<br>630<br>700<br>800<br>900<br>1000<br>1200<br>1250 | 12NES600T<br>12NES630T<br>12NES700T<br>12NES800T<br>12NES900T<br>12NES1000T<br>12NES1200T<br>12NES1250T | 630/800/1000/1250<br>A12NES1250T2                        |
|      | 4-Pole | NW4125T33W | NW4125T32W | –          | –          | 600<br>630<br>700<br>800<br>900<br>1000<br>1200<br>1250 | 12NES600T<br>12NES630T<br>12NES700T<br>12NES800T<br>12NES900T<br>12NES1000T<br>12NES1200T<br>12NES1250T | 630/800/1000/1250<br>A12NES1250T2                        |

### Moulded Case Switches<sup>①③</sup>

| Ampere Rating | Number of Poles | U <sub>e</sub> Max. 690 VAC Catalogue Number |                                |
|---------------|-----------------|--|--------------------------------|
| 800           | 3-Pole          | NW3800WK                                     | MCS Only without Line and Load |
|               | 4-Pole          | NW4800WK                                     |                                |
| 1250          | 3-Pole          | NW3125WK                                     | MCS Only without Line and Load |
|               | 4-Pole          | NW4125WK                                     |                                |
| 800           | 3-Pole          | HNW3800WK                                    | MCS Only without Line and Load |
|               | 4-Pole          | HNW4800WK                                    |                                |
| 1250          | 3-Pole          | HNW3125WK                                    | MCS Only without Line and Load |
|               | 4-Pole          | HNW4125WK                                    |                                |

① For AC use only.

② Special 50°C rating available. Order by description.

③ For 2-pole applications, use outer poles of 3-pole moulded case switch.

④ Order rating plug and terminals separately.

Selection Guide and Ordering Information

| Maximum Continuous Ampere Rating at 40°C①② | Number of Poles | Circuit Breaker Frame Including Digitrip RMS 310 Electronic Trip Unit Less Rating Plugs and Terminals<br>Order as Individual Component – Catalogue Number③  |                      |                      |                        | Digitrip RMS 310 Interchangeable Rating Plugs<br>Order as Individual Component |   |   |
|--|-----------------|---|----------------------|----------------------|------------------------|--|---|---|
|  |                 | L - Adjustable Long Delay Pickup (By Adjustable Rating Plug)<br>S - Adjustable Short Delay Pickup with Fixed Short Delay Time (I <sup>2</sup> t Response) or Adjustable Short Delay Time (Flat Response)<br>I - Adjustable Instantaneous Pickup by Setting Short Delay Time to Instantaneous<br>G - Adjustable Ground Fault Pickup with Adjustable Ground Fault Delay (Flat Response) | Fixed Rating Plug    |                      | Adjustable Rating Plug |  |   |   |
|  |                 |   | Ampere Rating        | Catalogue Number     | Ampere Rating          | Catalogue Number   |   |   |
| –  | –               | LS  | LSI                  | LSG                  | LSIG                   | –  | – | – |
| Short Time Range                           | –               | 2-8 x I <sub>n</sub>  | 2-8 x I <sub>n</sub> | 2-8 x I <sub>n</sub> | 2-8 x I <sub>n</sub>   | –  | – | – |
| Short Time Delay                           | –               | –   | 0-300 ms             | –                    | 0-300 ms               | –  | – | – |
| Ground Fault Pickup                        | –               | –   | –                    | 200-1200A            | 200-1200A              | –  | – | – |
| Ground Fault Delay                         | –               | –   | –                    | 0-500 ms             | 0-500 ms               | –  | – | – |

Type HNW Standard Interrupting Capacity – U<sub>e</sub> Max. 690 VAC, 70 kA I<sub>cu</sub> at 415 VAC

|        |             |             |             |             |             |           |                                   |  |
|--------|-------------|-------------|-------------|-------------|-------------|-----------|-----------------------------------|--|
| 800    | 2-Pole      | HNW2800T33W | HNW2800T32W | HNW2800T35W | HNW2800T36W | 400       | 8NES400T                          | Adjustable Settings Are:<br>400/500/630/800<br>8NES800T2 |
|        |             |             |             |             |             | 450       | 8NES450T                          |  |
|        |             |             |             |             |             | 500       | 8NES500T                          |  |
|        | 550         | 8NES550T    |             |             |             |           |                                   |  |
|        | 600         | 8NES600T    |             |             |             |           |                                   |  |
|        | 630         | 8NES630T    |             |             |             |           |                                   |  |
|        | 700         | 8NES700T    |             |             |             |           |                                   |  |
|        | 800         | 8NES800T    |             |             |             |           |                                   |  |
|        | 3-Pole      | HNW3800T33W | HNW3800T32W | HNW3800T35W | HNW3800T36W | 400       | 8NES400T                          |  |
| 450    |             |             |             |             |             | 8NES450T  |                                   |  |
| 500    |             |             |             |             |             | 8NES500T  |                                   |  |
| 550    | 8NES550T    |             |             |             |             |           |                                   |  |
| 600    | 8NES600T    |             |             |             |             |           |                                   |  |
| 630    | 8NES630T    |             |             |             |             |           |                                   |  |
| 700    | 8NES700T    |             |             |             |             |           |                                   |  |
| 800    | 8NES800T    |             |             |             |             |           |                                   |  |
| 4-Pole | HNW4800T33W | HNW4800T32W | –           | –           | 400         | 8NES400T  | 400/500/630/800<br>8NES800T2      |  |
|        |             |             | –           | –           | 450         | 8NES450T  |                                   |  |
|        |             |             | –           | –           | 500         | 8NES500T  |                                   |  |
| 550    | 8NES550T    |             |             |             |             |           |                                   |  |
| 600    | 8NES600T    |             |             |             |             |           |                                   |  |
| 630    | 8NES630T    |             |             |             |             |           |                                   |  |
| 700    | 8NES700T    |             |             |             |             |           |                                   |  |
| 800    | 8NES800T    |             |             |             |             |           |                                   |  |
| 1250   | 2-Pole      | HNW2125T33W | HNW2125T32W | HNW2125T35W | HNW2125T36W | 600       | 12NES600T                         | 630/800/1000/1250<br>A12NES1250T2                        |
|        |             |             |             |             |             | 630       | 12NES630T                         |  |
|        |             |             |             |             |             | 700       | 12NES700T                         |  |
|        |             |             |             |             |             | 800       | 12NES800T                         |  |
|        | 900         | 12NES900T   |             |             |             |           |                                   |  |
|        | 1000        | 12NES1000T  |             |             |             |           |                                   |  |
|        | 1200        | 12NES1200T  |             |             |             |           |                                   |  |
|        | 1250        | 12NES1250T  |             |             |             |           |                                   |  |
|        | 3-Pole      | HNW3125T33W | HNW3125T32W | HNW3125T35W | HNW3125T36W | 600       | 12NES600T                         | 630/800/1000/1250<br>A12NES1250T2                        |
|        |             |             |             |             |             | 630       | 12NES630T                         |  |
|        |             |             |             |             |             | 700       | 12NES700T                         |  |
|        |             |             |             |             |             | 800       | 12NES800T                         |  |
| 900    | 12NES900T   |             |             |             |             |           |                                   |  |
| 1000   | 12NES1000T  |             |             |             |             |           |                                   |  |
| 1200   | 12NES1200T  |             |             |             |             |           |                                   |  |
| 1250   | 12NES1250T  |             |             |             |             |           |                                   |  |
| 4-Pole | HNW4125T33W | HNW4125T32W | –           | –           | 600         | 12NES600T | 630/800/1000/1250<br>A12NES1250T2 |  |
|        |             |             | –           | –           | 630         | 12NES630T |                                   |  |
|        |             |             | –           | –           | 700         | 12NES700T |                                   |  |
|        |             |             | –           | –           | 800         | 12NES800T |                                   |  |
| 900    | 12NES900T   |             |             |             |             |           |                                   |  |
| 1000   | 12NES1000T  |             |             |             |             |           |                                   |  |
| 1200   | 12NES1200T  |             |             |             |             |           |                                   |  |
| 1250   | 12NES1250T  |             |             |             |             |           |                                   |  |

① For AC use only.  
② Special 50°C rating available.  
Order by description.  
③ Order rating plug and terminals separately.

Cutler-Hammer Frame Size N, 400-1250 Amperes 100 kA

### Selection Guide and Ordering Information

| Maximum Continuous Ampere Rating at 40°C <sup>①②</sup> | Number of Poles | Circuit Breaker Frame Including Digitrip RMS 310 Electronic Trip Unit Less Rating Plugs and Terminals<br>Order as Individual Component – Catalogue Number <sup>③</sup>  |                      |                      |                        | Digitrip RMS 310 Interchangeable Rating Plugs<br>Order as Individual Component |   |   |
|--|-----------------|---|----------------------|----------------------|------------------------|--|---|---|
|  |                 | L - Adjustable Long Delay Pickup (By Adjustable Rating Plug)<br>S - Adjustable Short Delay Pickup with Fixed Short Delay Time (I <sup>2</sup> t Response) or Adjustable Short Delay Time (Flat Response)<br>I - Adjustable Instantaneous Pickup by Setting Short Delay Time to Instantaneous<br>G - Adjustable Ground Fault Pickup with Adjustable Ground Fault Delay (Flat Response) | Fixed Rating Plug    |                      | Adjustable Rating Plug |  |   |   |
|  |                 |   | Ampere Rating        | Catalogue Number     | Ampere Rating          | Catalogue Number   |   |   |
| –  | –               | LS  | LSI                  | LSG                  | LSIG                   | –  | – | – |
| Short Time Range                                       | –               | 2-8 x I <sub>n</sub>  | 2-8 x I <sub>n</sub> | 2-8 x I <sub>n</sub> | 2-8 x I <sub>n</sub>   | –  | – | – |
| Short Time Delay                                       | –               | –   | 0-300 ms             | –                    | 0-300 ms               | –  | – | – |
| Ground Fault Pickup                                    | –               | –   | –                    | 200-1200A            | 200-1200A              | –  | – | – |
| Ground Fault Delay                                     | –               | –   | –                    | 0-500 ms             | 0-500 ms               | –  | – | – |

#### Type NWC Standard Interrupting Capacity – U<sub>e</sub> Max. 690 VAC, 100 kA I<sub>cu</sub> at 415 VAC

|      |        |             |             |             |             |      |   |  |
|------|--------|-------------|-------------|-------------|-------------|------|---|--|
| 800  | 2-Pole | NWC2800T33W | NWC2800T32W | NWC2800T35W | NWC2800T36W | 400  | 8NES400T<br>8NES450T<br>8NES500T<br>8NES550T        | Adjustable Settings Are:<br>400/500/630/800<br>8NES800T2 |
|      |        |             |             |             |             | 450  |   |  |
|      |        |             |             |             |             | 500  |   |  |
|      | 3-Pole | NWC3800T33W | NWC3800T32W | NWC3800T35W | NWC3800T36W | 550  | 8NES600T<br>8NES630T<br>8NES700T<br>8NES800T        |  |
|      |        |             |             |             |             | 600  |   |  |
|      |        |             |             |             |             | 630  |   |  |
|      | 4-Pole | NWC4800T33W | NWC4800T32W | –           | –           | 700  | 8NES400T<br>8NES450T<br>8NES500T<br>8NES550T        |  |
|      |        |             |             |             |             | 800  |   |  |
|      |        |             |             |             |             | 600  |   |  |
| 1250 | 2-Pole | NWC2125T33W | NWC2125T32W | NWC2125T35W | NWC2125T36W | 600  | 12NES600T<br>12NES630T<br>12NES700T<br>12NES800T    | 630/800/1000/1250<br>A12NES1250T2                        |
|      |        |             |             |             |             | 630  |   |  |
|      |        |             |             |             |             | 700  |   |  |
|      | 3-Pole | NWC3125T33W | NWC3125T32W | NWC3125T35W | NWC3125T36W | 800  | 12NES900T<br>12NES1000T<br>12NES1200T<br>12NES1250T |  |
|      |        |             |             |             |             | 900  |   |  |
|      |        |             |             |             |             | 1000 |   |  |
|      | 4-Pole | NWC4125T33W | NWC4125T32W | –           | –           | 1200 | 12NES600T<br>12NES630T<br>12NES700T<br>12NES800T    |  |
|      |        |             |             |             |             | 1250 |   |  |
|      |        |             |             |             |             | 600  |   |  |
|      | 2-Pole | NWC2125T33W | NWC2125T32W | NWC2125T35W | NWC2125T36W | 600  | 12NES900T<br>12NES1000T<br>12NES1200T<br>12NES1250T | 630/800/1000/1250<br>A12NES1250T2                        |
|      |        |             |             |             |             | 630  |   |  |
|      |        |             |             |             |             | 700  |   |  |
|      | 3-Pole | NWC3125T33W | NWC3125T32W | NWC3125T35W | NWC3125T36W | 800  | 12NES600T<br>12NES630T<br>12NES700T<br>12NES800T    |  |
|      |        |             |             |             |             | 900  |   |  |
|      |        |             |             |             |             | 1000 |   |  |
|      | 4-Pole | NWC4125T33W | NWC4125T32W | –           | –           | 1200 | 12NES900T<br>12NES1000T<br>12NES1200T<br>12NES1250T |  |
|      |        |             |             |             |             | 1250 |   |  |
|      |        |             |             |             |             | 600  |   |  |

① For AC use only.

② Special 50°C rating available.  
Order by description.

③ Order rating plug and terminals separately.



**Cutler-Hammer Frame Size N, 400-1250 Amperes**

**Selection Guide and Ordering Information**

**Line and Load Terminals**

N-Frame circuit breakers include Cu/Al terminals as standard. When optional copper or Cu/Al terminals are required, order by catalogue number.

| Maximum Breaker Amperes                                  | Terminal Body Material | Wire Type | Metric Wire Range mm <sup>2</sup> | AWG Wire Number of Conductors | Catalogue Number |
|--|------------------------|-----------|-----------------------------------|-------------------------------|------------------|
| <b>Standard Cu/Al Pressure-Type Terminals</b>            |                        |           |                                   |                               |                  |
| 1250   | Aluminium              | Cu/Al     | 120-300                           | 4/0-500 (3)                   | TA1200NB3M       |
| <b>Optional Copper and Cu/Al Pressure Type Terminals</b> |                        |           |                                   |                               |                  |
| 1250   | Copper                 | Copper    | 95-185                            | 3/0-400 (4)                   | T1200NB3M        |

**Base Mounting Hardware**

Base mounting hardware is included with a circuit breaker or moulded case switch.

**Imperial Thread**

| Number of Poles    | Description  | Catalogue Number |
|--------------------|--|------------------|
| 2-, 3-, and 4-pole | 0.3125-18 x 1.25 Inch Pan-Head Steel Screws and Lock Washers | BMH5M            |

**Keeper Nut**

Not required on N-Frame. Terminals are threaded.

**Handle Extension**

Included with breaker. Additional handle extensions are available.

|                                |
|--------------------------------|
| <b>Single Handle Extension</b> |
| Catalogue Number – HEX5        |

**Interphase Barriers**

The interphase barriers provide additional electrical clearance between circuit breaker poles for special termination applications. Barriers are high dielectric insulating plates that are installed in the Moulded slots between the terminals. (Field installation only.)

|                            |
|----------------------------|
| <b>Interphase Barriers</b> |
| Catalogue Number – IPB5    |

Cutler-Hammer Frame Size R, 800-2500 Amperes 70 kA at 415 VAC

### Selection Guide and Ordering Information

| Maximum Continuous Ampere Rating at 40°C <sup>①②</sup> | Number of Poles | Circuit Breaker Frame Including Digitrip RMS 310 Electronic Trip Unit Less Rating Plugs and Terminals<br>Order as Individual Component – Catalogue Number <sup>⑤</sup>  |                      |                      |                        | Digitrip RMS 310 Interchangeable Rating Plugs<br>Order as Individual Component |   |   |
|--|-----------------|---|----------------------|----------------------|------------------------|--|---|---|
|  |                 | L - Adjustable Long Delay Pickup (By Adjustable Rating Plug)<br>S - Adjustable Short Delay Pickup with Fixed Short Delay Time (I <sup>2</sup> t Response) or Adjustable Short Delay Time (Flat Response)<br>I - Adjustable Instantaneous Pickup by Setting Short Delay Time to Instantaneous<br>G - Adjustable Ground Fault Pickup with Adjustable Ground Fault Delay (Flat Response) | Fixed Rating Plug    |                      | Adjustable Rating Plug |  |   |   |
|  |                 |   | Ampere Rating        | Catalogue Number     | Ampere Rating          | Catalogue Number   |   |   |
| –  | –               | LS  | LSI                  | LSG <sup>④</sup>     | LSIG <sup>③</sup>      | –  | – | – |
| Short Time Range                                       |                 | 2-8 x I <sub>n</sub>  | 2-8 x I <sub>n</sub> | 2-8 x I <sub>n</sub> | 2-8 x I <sub>n</sub>   |  |   |   |
| Short Time Delay                                       |                 | –   | 0-300 ms             | –                    | 0-300 ms               |  |   |   |
| Ground Fault Pickup                                    |                 | –   | –                    | 200-1200A            | 200-1200A              |  |   |   |
| Ground Fault Delay                                     |                 | –   | –                    | 0-500 ms             | 0-500 ms               |  |   |   |

#### Type RW with Digitrip 310 Standard Interrupting Capacity – U<sub>e</sub> Max. 690 VAC, 70 kA I<sub>cu</sub> at 415 VAC

|                   |                     |           |           |           |                      |                                      |  |  |
|-------------------|---------------------|-----------|-----------|-----------|----------------------|--------------------------------------|--|--|
| 1600 <sup>①</sup> | 3-Pole              | RW316T33W | RW316T32W | RW316T35W | RW316T36W            | 800<br>1000<br>1200<br>1250          | 16RES08T<br>16RES10T<br>16RES12T<br>16RES125T                | Adjustable Settings Are:<br>800/1000/1200/1600<br>A16RES16T1           |
|                   |                     |           |           |           |                      | 1400<br>1500<br>1600                 | 16RES14T<br>16RES15T<br>16RES16T                             |  |
| 2000              |                     | RW320T33W | RW320T32W | RW320T35W | RW320T36W            | 1000<br>1200<br>1250                 | 20RES10T<br>20RES12T<br>A20RES125T                           | 1000/1200/1600/2000<br>A20RES20T1                                      |
|                   |                     |           |           |           | 1400<br>1600<br>2000 | A20RES14T<br>A20RES16T<br>A20RES20T  | 1000/1250/1600/2000<br>A20RES20T2                            |  |
| 2500              |                     | RW325T33W | RW325T32W | RW325T35W | RW325T36W            | 1200<br>1250<br>1600<br>2000<br>2500 | 25RES12T<br>25RES125T<br>A25RES16T<br>A25RES20T<br>A25RES25T | 1200/1600/2000/2500<br>A25RES25T1<br>1250/1600/2000/2500<br>A25RES25T2 |
| 1600 <sup>①</sup> | 4-Pole <sup>③</sup> | RW416T33W | RW416T32W | –         | –                    | 800<br>1000<br>1200<br>1250          | 16RES08T<br>16RES10T<br>16RES12T<br>16RES125T                | 800/1000/1200/1600<br>A16RES16T1                                       |
|                   |                     |           |           |           |                      | 1400<br>1500<br>1600                 | 16RES14T<br>16RES15T<br>16RES16T                             |  |
| 2000              |                     | RW420T33W | RW420T32W | –         | –                    | 1000<br>1200<br>1250                 | 20RES10T<br>20RES12T<br>A20RES125T                           | 1000/1200/1600/2000<br>A20RES20T1                                      |
|                   |                     |           |           |           | 1400<br>1600<br>2000 | A20RES14T<br>A20RES16T<br>A20RES20T  | 1000/1250/1600/2000<br>A20RES20T2                            |  |
| 2500              |                     | RW425T33W | RW425T32W | –         | –                    | 1200<br>1250<br>1600<br>2000<br>2500 | 25RES12T<br>25RES125T<br>A25RES16T<br>A25RES20T<br>A25RES25T | 1200/1600/2000/2500<br>A25RES25T1<br>1250/1600/2000/2500<br>A25RES25T2 |

① For SCR application, use 2000A frame.

② Special 50°C rating available. Order by description.

③ Unprotected left pole neutral. Add "P" to catalogue number for 100% protected left pole neutral, add "E" for 60% protected, i.e., "RW416T33PW", "RW416T33EW".

④ Ground fault equipped trip units available with remote indicating panel. Add "R" to catalogue number, i.e., "RW316T35RW".

⑤ Order rating plug and terminals separately. Mounting hardware not included.

Selection Guide and Ordering Information

| Maximum Continuous Ampere Rating at 40°C <sup>①②</sup> | Number of Poles | Circuit Breaker Frame Including Digitrip RMS 310 Electronic Trip Unit Less Rating Plugs and Terminals<br>Order as Individual Component – Catalogue Number <sup>⑤</sup>  |                      |                      |                      | Digitrip RMS 310 Interchangeable Rating Plugs<br>Order as Individual Component |                  |                                |
|--|-----------------|---|----------------------|----------------------|----------------------|--|------------------|--------------------------------|
|  |                 | L - Adjustable Long Delay Pickup (By Adjustable Rating Plug)<br>S - Adjustable Short Delay Pickup with Fixed Short Delay Time (I <sup>2</sup> t Response) or Adjustable Short Delay Time (Flat Response)<br>I - Adjustable Instantaneous Pickup by Setting Short Delay Time to Instantaneous<br>G - Adjustable Ground Fault Pickup with Adjustable Ground Fault Delay (Flat Response) |                      |                      |                      | Fixed Rating Plug  |                  | Adjustable Rating Plug         |
|  |                 |   |                      |                      |                      | Ampere Rating  | Catalogue Number | Ampere Rating Catalogue Number |
| –  | –               | LS  | LSI                  | LSG <sup>④</sup>     | LSIG <sup>④</sup>    | –  | –                | –                              |
| Short Time Range                                       | –               | 2-8 x I <sub>n</sub>  | 2-8 x I <sub>n</sub> | 2-8 x I <sub>n</sub> | 2-8 x I <sub>n</sub> | –  | –                | –                              |
| Short Time Delay                                       | –               | –   | 0-300 ms             | –                    | 0-300 ms             | –  | –                | –                              |
| Ground Fault Pickup                                    | –               | –   | –                    | 200-1200A            | 200-1200A            | –  | –                | –                              |
| Ground Fault Delay                                     | –               | –   | –                    | 0-500 ms             | 0-500 ms             | –  | –                | –                              |

Type RWC with Digitrip 310 High Interrupting Capacity – U<sub>e</sub> Max. 690 VAC, 100 kA I<sub>cu</sub> at 415 VAC

| Maximum Continuous Ampere Rating | Number of Poles     | LS         | LSI        | LSG <sup>④</sup> | LSIG <sup>④</sup> | Fixed Rating Plug            | Adjustable Rating Plug                        |
|----------------------------------|---------------------|------------|------------|------------------|-------------------|------------------------------|---|
| 1600 <sup>①</sup>                | 3-Pole              | RWC316T33W | RWC316T32W | RWC316T35W       | RWC316T36W        | 800<br>1000<br>1200<br>1250  | 16RES08T<br>16RES10T<br>16RES12T<br>16RES125T |
| 2000                             |                     | RWC320T33W | RWC320T32W | RWC320T35W       | RWC320T36W        | 1400<br>1500<br>1600         | 16RES14T<br>16RES15T<br>16RES16T              |
| 1600 <sup>①</sup>                | 4-Pole <sup>③</sup> | RWC416T33W | RWC416T32W | –                | –                 | 800<br>1000<br>1200<br>1250  | 16RES08T<br>16RES10T<br>16RES12T<br>16RES125T |
| 2000                             |                     | RWC420T33W | RWC420T32W | –                | –                 | 1400<br>1500<br>1600<br>2000 | 16RES14T<br>16RES15T<br>16RES16T<br>A20RES20T |
| 1600 <sup>①</sup>                | 3-Pole              | RWC316T33W | RWC316T32W | RWC316T35W       | RWC316T36W        | 800<br>1000<br>1200<br>1250  | 16RES08T<br>16RES10T<br>16RES12T<br>16RES125T |
| 2000                             |                     | RWC320T33W | RWC320T32W | RWC320T35W       | RWC320T36W        | 1400<br>1500<br>1600<br>2000 | 16RES14T<br>16RES15T<br>16RES16T<br>A20RES20T |
| 1600 <sup>①</sup>                | 4-Pole <sup>③</sup> | RWC416T33W | RWC416T32W | –                | –                 | 800<br>1000<br>1200<br>1250  | 16RES08T<br>16RES10T<br>16RES12T<br>16RES125T |
| 2000                             |                     | RWC420T33W | RWC420T32W | –                | –                 | 1400<br>1500<br>1600<br>2000 | 16RES14T<br>16RES15T<br>16RES16T<br>A20RES20T |

Moulded Case Switches

| Ampere Rating  | Number of Poles | Catalogue Number   |
|----------------|-----------------|--------------------|
| 1600A<br>2000A | 3-Pole          | RW316WK<br>RW320WK |
| 1600A<br>2000A | 4-Pole          | RW416WK<br>RW420WK |

① For SCR application, use 2000A frame.

② Special 50°C rating available. Order by description.

③ Unprotected left pole neutral. Add "P" to catalogue number for 100% protected left pole neutral, add "E" for 60% protected, i.e., "RW416T33PW", "RW416T33EW".

④ Ground fault equipped trip units available with remote indicating panel. Add "R" to catalogue number, i.e., "RW316T35RW".

⑤ Order rating plug and terminals separately. Mounting hardware not included.

Cutler-Hammer Frame Size R, 800-1250 Amperes 70 kA at 415 VAC and 100 kA at 415 VAC

### Selection Guide and Ordering Information

| Maximum Continuous Ampere Rating at 40°C <sup>①</sup> | Number of Poles | Circuit Breaker Frame Including Digitrip 610 and and 910 Electronic Trip Unit Less Rating Plugs and Terminals Order as Individual Component – Catalogue Number <sup>②</sup> |   |                                     |   |                                    | Digitrip RMS Interchangeable Rating Plug Order as Individual Component |                  |   |
|---|-----------------|---|---|-------------------------------------|---|------------------------------------|--|------------------|---|
|   |                 | L - Adjustable Long Delay Pickup ( $I_r$ ) with Adjustable Long Delay Time  | S - Adjustable Short Delay Pickup with Adjustable Short Delay Time ( $I^2t$ or Flat Response) | I - Adjustable Instantaneous Pickup | G - Adjustable Ground Fault Pickup with Adjustable Ground Fault Time Delay ( $I^2t$ or Flat Response) | Fixed Rating Plug                  | Ampere Rating  | Catalogue Number |   |
| –   | –               | LI  | LS  | LSI                                 | LIG   | LSG                                | LSIG   | –                | – |
| Long Delay Pickup                                     |                 | $0.5-1.0 \times I_n$  | $0.5-1.0 \times I_n$  | $0.5-1.0 \times I_n$                | $0.5-1.0 \times I_n$  | $0.5-1.0 \times I_n$               | $0.5-1.0 \times I_n$   |                  |   |
| Long Delay Time                                       |                 | 2-24 Seconds  | 2-24 Seconds  | 2-24 Seconds                        | 2-24 Seconds  | 2-24 Seconds                       | 2-24 Seconds   |                  |   |
| Short Time Range                                      |                 | $2-6 \times I_r$  | $2-6 \times I_r$  | $2-6 \times I_r$                    | $2-6 \times I_r$  | $2-6 \times I_r$                   | $2-6 \times I_r$   |                  |   |
| Short Time Delay                                      |                 | –   | 100-500 ms  | 100-500 ms                          | –   | 100-500 ms                         | 100-500 ms   |                  |   |
| Instantaneous   |                 | $2-6 \times M1$ & $M2$  | –   | $2-6 \times M1$ & $M2$              | $2-6 \times M1$ & $M2$  | –                                  | $2-6 \times M1$ & $M2$   |                  |   |
| Ground Fault Pickup                                   |                 | –   | –   | –                                   | $0.25-1.0 \times I_n$ <sup>③</sup>  | $0.25-1.0 \times I_n$ <sup>③</sup> | $0.25-1.0 \times I_n$ <sup>③</sup>                                     |                  |   |
| Ground Fault Delay                                    |                 | –   | –   | –                                   | 100-500 ms  | 100-500 ms                         | 100-500 ms   |                  |   |

#### Type RW with Digitrip 610 Standard Interrupting Capacity – $U_e$ Max. 690 VAC, 70 kA $I_{cu}$ at 415 VAC

| Rating | Poles  | LI        | LS        | LSI       | LIG       | LSG       | LSIG      | Rating | Ordering Code |
|--------|--------|-----------|-----------|-----------|-----------|-----------|-----------|--------|---------------|
| 1600   | 3-Pole | RW316T61W | RW316T63W | RW316T62W | RW316T64W | RW316T65W | RW316T66W | 800    | RP6R16A080    |
|        |        |           |           |           |           |           |           | 1000   | RP6R16A100    |
|        |        |           |           |           |           |           |           | 1200   | RP6R16A120    |
|        |        |           |           |           |           |           |           | 1250   | RP6R16A125    |
|        |        |           |           |           |           |           |           | 1600   | RP6R16A160    |
| 2000   | 3-Pole | RW320T61W | RW320T63W | RW320T62W | RW320T64W | RW320T65W | RW320T66W | 1000   | RP6R20A100    |
|        |        |           |           |           |           |           |           | 1200   | RP6R20A120    |
|        |        |           |           |           |           |           |           | 1250   | RP6R20A125    |
|        |        |           |           |           |           |           |           | 1600   | RP6R20A160    |
|        |        |           |           |           |           |           |           | 2000   | RP6R20A200    |
| 2500   | 3-Pole | RW325T61W | RW325T63W | RW325T62W | RW325T64W | RW325T65W | RW325T66W | 1600   | RP6R25A160    |
|        |        |           |           |           |           |           |           | 2000   | RP6R25A200    |
|        |        |           |           |           |           |           |           | 2500   | RP6R25A250    |

#### Type RWC with Digitrip 610 High Interrupting Capacity – $U_e$ Max. 690 VAC, 100 kA $I_{cu}$ at 415 VAC

| Rating | Poles  | LI         | LS         | LSI        | LIG        | LSG        | LSIG       | Rating | Ordering Code |
|--------|--------|------------|------------|------------|------------|------------|------------|--------|---------------|
| 1600   | 3-Pole | RWC316T61W | RWC316T63W | RWC316T62W | RWC316T64W | RWC316T65W | RWC316T66W | 800    | RP6R16A080    |
|        |        |            |            |            |            |            |            | 1000   | RP6R16A100    |
|        |        |            |            |            |            |            |            | 1200   | RP6R16A120    |
|        |        |            |            |            |            |            |            | 1250   | RP6R16A125    |
|        |        |            |            |            |            |            |            | 1600   | RP6R16A160    |
| 2000   | 3-Pole | RWC320T61W | RWC320T63W | RWC320T62W | RWC320T64W | RWC320T65W | RWC320T66W | 1000   | RP6R20A100    |
|        |        |            |            |            |            |            |            | 1200   | RP6R20A120    |
|        |        |            |            |            |            |            |            | 1250   | RP6R20A125    |
|        |        |            |            |            |            |            |            | 1600   | RP6R20A160    |
|        |        |            |            |            |            |            |            | 2000   | RP6R20A200    |

#### Type RW with Digitrip 910 Standard Interrupting Capacity – $U_e$ Max. 690 VAC, 70 kA $I_{cu}$ at 415 VAC

| Rating | Poles  | LI        | LS        | LSI       | LIG       | LSG       | LSIG      | Rating | Ordering Code |
|--------|--------|-----------|-----------|-----------|-----------|-----------|-----------|--------|---------------|
| 1600   | 3-Pole | RW316T91W | RW316T93W | RW316T92W | RW316T94W | RW316T95W | RW316T96W | 800    | RP6R16A080    |
|        |        |           |           |           |           |           |           | 1000   | RP6R16A100    |
|        |        |           |           |           |           |           |           | 1200   | RP6R16A120    |
|        |        |           |           |           |           |           |           | 1250   | RP6R16A125    |
|        |        |           |           |           |           |           |           | 1600   | RP6R16A160    |
| 2000   | 3-Pole | RW320T91W | RW320T93W | RW320T92W | RW320T94W | RW320T95W | RW320T96W | 1000   | RP6R20A100    |
|        |        |           |           |           |           |           |           | 1200   | RP6R20A120    |
|        |        |           |           |           |           |           |           | 1250   | RP6R20A125    |
|        |        |           |           |           |           |           |           | 1600   | RP6R20A160    |
|        |        |           |           |           |           |           |           | 2000   | RP6R20A200    |
| 2500   | 3-Pole | RW325T91W | RW325T93W | RW325T92W | RW325T94W | RW325T95W | RW325T96W | 1600   | RP6R25A160    |
|        |        |           |           |           |           |           |           | 2000   | RP6R25A200    |
|        |        |           |           |           |           |           |           | 2500   | RP6R25A250    |

#### Type RWC with Digitrip 910 High Interrupting Capacity – $U_e$ Max. 690 VAC, 100 kA $I_{cu}$ at 415 VAC

| Rating | Poles  | LI         | LS         | LSI        | LIG        | LSG        | LSIG       | Rating | Ordering Code |
|--------|--------|------------|------------|------------|------------|------------|------------|--------|---------------|
| 1600   | 3-Pole | RWC316T91W | RWC316T93W | RWC316T92W | RWC316T94W | RWC316T95W | RWC316T96W | 800    | RP6R16A080    |
|        |        |            |            |            |            |            |            | 1000   | RP6R16A100    |
|        |        |            |            |            |            |            |            | 1200   | RP6R16A120    |
|        |        |            |            |            |            |            |            | 1250   | RP6R16A125    |
|        |        |            |            |            |            |            |            | 1600   | RP6R16A160    |
| 2000   | 3-Pole | RWC320T91W | RWC320T93W | RWC320T92W | RWC320T94W | RWC320T95W | RWC320T96W | 1000   | RP6R20A100    |
|        |        |            |            |            |            |            |            | 1200   | RP6R20A120    |
|        |        |            |            |            |            |            |            | 1250   | RP6R20A125    |
|        |        |            |            |            |            |            |            | 1600   | RP6R20A160    |
|        |        |            |            |            |            |            |            | 2000   | RP6R20A200    |

① Special 50°C rating available. Order by description.

② Order rating plug and terminals separately. Mounting hardware not included.

③ Not to exceed 1200A ground fault pick-up.

Selection Guide and Ordering Information

Line and Load Terminals

R-Frame circuit breakers have Cu/Al terminals as standard and copper only terminals as an option. Specify if factory installation is required.

| Maximum Breaker Amperes | Terminal Body Material | Wire Type | Hardware | AWG/kmil Wire Range/Number of Conductors | Metric Wire Range mm <sup>2</sup> | Catalogue Number |
|-------------------------|------------------------|-----------|----------|--|-----------------------------------|------------------|
|-------------------------|------------------------|-----------|----------|--|-----------------------------------|------------------|

Wire Terminals

|      |           |       |         |              |         |          |
|------|-----------|-------|---------|--------------|---------|----------|
| 1600 | Aluminium | Cu/Al | English | 500-1000 (4) | 300-500 | TA1600RD |
| 1600 | Copper    | Cu    | English | 1-600 (4)    | 50-300  | T1600RD  |
| 2000 | Aluminium | Cu/Al | English | 2-600 (6)    | 35-300  | TA2000RD |

Rear Connectors

|      |        |   |         |   |   |          |
|------|--------|---|---------|---|---|----------|
| 2000 | Copper | - | English | - | - | B2016RD  |
| 2000 | Copper | - | English | - | - | B2016RDL |
| 2500 | Copper | - | English | - | - | B2500RD  |

RD Rear Connector Exploded View

TA2000RD<sup>①</sup>

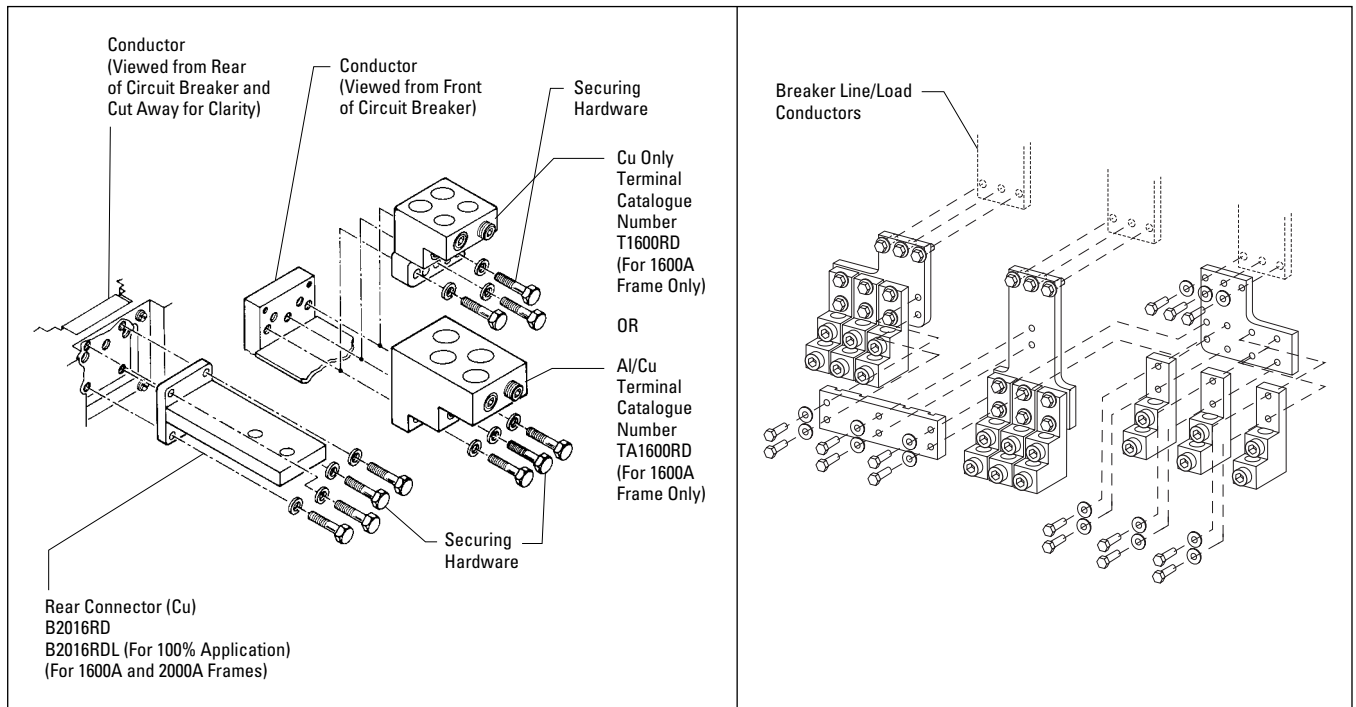

Base Mounting Hardware

Supplied by customer.

Handle Extension

Included with breaker. Additional handle extensions are available.

|                         |
|-------------------------|
| Single Handle Extension |
| Catalogue Number – HEX6 |

<sup>①</sup> Catalogue number includes bus connection, terminals, and hardware for either line side or load side of 3-pole breaker.

## Motor Circuit Protectors

### Selection Guide and Ordering Information

#### Circuit Breakers for Motor Protection

| Breaker Type | Rated Current I <sub>n</sub> | Rated Output of 3-Phase Motors <sup>①</sup> to Be Protected at 50 Hz |              | Setting Current of Inverse-Time Overload Release I <sub>r</sub> | Instantaneous Short Circuit Release I <sub>i</sub> | Trip Class T <sub>c</sub> | Standard Switching Capacity Catalogue Number | High Switching Capacity Catalogue Number |
|--------------|------------------------------|--|--------------|---|--|---------------------------|--|--|
|              |                              | 380/415V Max. kW   | 500V Max. kW |   |  |                           |  |  |

#### Without Adjustment of the Trip Class, without Phase Unbalance Detection

| Breaker Type | Rated Current I <sub>n</sub> | 380/415V Max. kW | 500V Max. kW | Setting Current of Inverse-Time Overload Release I <sub>r</sub> | Instantaneous Short Circuit Release I <sub>i</sub> | Trip Class T <sub>c</sub> | 40 kA at 380/415 VAC                         | 70 kA at 380/415 VAC                     |
|--------------|------------------------------|------------------|--------------|---|--|---------------------------|--|--|
|              |                              |                  |              |   |  |                           | Standard Switching Capacity Catalogue Number | High Switching Capacity Catalogue Number |
| FWMP         | 80                           | 37               | 55           | 40-80   | 15 x I <sub>r</sub>                                | 10                        | FWMP3080L                                    | HFWMP3080L                               |
| FWMP         | 100                          | 45               | 55           | 80-100  | 15 x I <sub>r</sub>                                | 10                        | FWMP3100L                                    | HFWMP3100L                               |
| FWMP         | 160                          | 75               | 110          | 100-160   | 15 x I <sub>r</sub>                                | 10                        | FWMP3160L                                    | HFWMP3160L                               |
| FWMP         | 205                          | 110              | 132          | 160-205   | 13 x I <sub>r</sub>                                | 10                        | FWMP3205L                                    | HFWMP3205L                               |
| KWMP         | 315                          | 160              | 200          | 160-315   | 15 x I <sub>r</sub>                                | 20                        | KWMP3315W                                    | HKWMP3315W                               |
| LWMP         | 500                          | 250              | 355          | 250-500   | 15 x I <sub>r</sub>                                | 20                        | LWMP3500W                                    | HLWMP3500W                               |

#### With Adjustment of the Trip Class, with Phase Unbalance Detection

| Breaker Type | Rated Current I <sub>n</sub> | 380/415V Max. kW | 500V Max. kW | Setting Current of Inverse-Time Overload Release I <sub>r</sub> | Instantaneous Short Circuit Release I <sub>i</sub> | Trip Class T <sub>c</sub> | 35 kA at 380/415 VAC                         | 65 kA at 380/415 VAC                     |
|--------------|------------------------------|------------------|--------------|---|--|---------------------------|--|--|
|              |                              |                  |              |   |  |                           | Standard Switching Capacity Catalogue Number | High Switching Capacity Catalogue Number |
| FWMP-J       | 80                           | 37               | 55           | 40-80   | 15 x I <sub>r</sub>                                | 5/10/15/20                | FWMP3080JL                                   | HFWMP3080JL                              |
| FWMP-J       | 100                          | 45               | 55           | 80-100  | 15 x I <sub>r</sub>                                | 5/10/15/20                | FWMP3100JL                                   | HFWMP3100JL                              |
| FWMP-J       | 160                          | 75               | 110          | 100-160   | 15 x I <sub>r</sub>                                | 5/10/15/20                | FWMP3160JL                                   | HFWMP3160JL                              |
| FWMP-J       | 205                          | 110              | 132          | 160-205   | 13 x I <sub>r</sub>                                | 10                        | FWMP3205JL                                   | HFWMP3205JL                              |
| KWMP-J       | 315                          | 160              | 200          | 160-315   | 15 x I <sub>r</sub>                                | 10/15/20/30               | KWMP3315JW                                   | HKWMP3315JW                              |
| LWMP-J       | 500                          | 250              | 355          | 250-500   | 15 x I <sub>r</sub>                                | 20                        | LWMP3500JW                                   | HLWMP3500JW                              |

#### Motor Circuit Protectors for Combination Starters

| Breaker Type | Rated Current I <sub>n</sub> | 380/415V Max. kW | 500V Max. kW | Setting Current of Inverse-Time Overload Release I <sub>r</sub> | Instantaneous Short Circuit Release I <sub>i</sub> | Trip Class T <sub>c</sub> | 35 kA at 380/415 VAC                         | 65 kA at 380/415 VAC <sup>①</sup>        |
|--------------|------------------------------|------------------|--------------|---|--|---------------------------|--|--|
|              |                              |                  |              |   |  |                           | Standard Switching Capacity Catalogue Number | High Switching Capacity Catalogue Number |
| HMCP         | Up to 63                     | 30               | 37           | —   | 300-1000   | —                         | —  | HMCPJ250R3                               |
| HMCP         | Up to 100                    | 45               | 55           | —   | 450-1500   | —                         | —  | HMCPJ250C5                               |
| HMCP         | Up to 150                    | 75               | 110          | —   | 750-1500   | —                         | —  | HMCPJ250G5                               |
| HMCP         | Up to 125                    | 55               | 75           | —   | 1000-2000  | —                         | —  | HMCPJ250K5                               |
| HMCP         | Up to 160                    | 75               | 110          | —   | 1125-2250  | —                         | —  | HMCPJ250L5                               |
| HMCP         | Up to 200                    | 90               | 132          | —   | 1250-2500  | —                         | —  | HMCPJ250W5                               |
| HMCP         | Up to 200                    | 90               | 132          | —   | 1500-3000  | —                         | —  | HMCP400N5                                |
| HMCP         | Up to 250                    | 110              | 160          | —   | 1750-3500  | —                         | —  | HMCP400R5                                |
| HMCP         | Up to 315                    | 160              | 200          | —   | 2000-4000  | —                         | —  | HMCP400X5                                |
| HMCP         | Up to 315                    | 160              | 200          | —   | 1800-6000  | —                         | —  | HMCP600L6W                               |
| HMCP         | Up to 400                    | 200              | 250          | —   | 1800-6000  | —                         | —  | HMCP600L6W                               |
| HMCP         | Up to 500                    | 250              | 355          | —   | 1800-6000  | —                         | —  | HMCP600L6W                               |

① Combination ratings with Cutler-Hammer Freedom® / ADVANTAGE® Control, contact Cutler-Hammer.

**Selection Guide and Ordering Information**

**Special Calibration**

Special non-UL listed calibrations are available for certain ambient temperatures other than 40°C and for frequencies other than 50/60 Hz or dc. Reduced interrupting ratings will apply for 400 Hz applications.

**50°C Calibration<sup>①</sup>**

Add suffix "V" to catalogue number for complete breaker when ordering listed ampere ratings for breakers to be used in 50°C ambients.

Contact Cutler-Hammer for availability.

**Moisture-Fungus Treatment**

All Cutler-Hammer Circuit Breaker cases are moulded from glass-poly-ester which does not support the growth of fungus. Any parts which are susceptible to the growth of fungus will require special treatment.

Order by description.

| Accessory                 | Frame |      |      |   |   |   |   |
|---------------------------|-------|------|------|---|---|---|---|
|                           | G     | E125 | J250 | K | L | N | R |
| Special Calibration       | ✓     | ✓    | ✓    | ✓ | ✓ | ✓ | ✓ |
| Moisture-Fungus Treatment | ✓     | ✓    | ✓    | ✓ | ✓ | ✓ | ✓ |

| Accessory | Fit Type | Frame |      |      |   |   |   |   |
|-----------|----------|-------|------|------|---|---|---|---|
|           |          | G     | E125 | J250 | K | L | N | R |

**External Accessory Catalogue Numbers**

|   |                |                      |          |          |           |          |          |          |
|---|----------------|----------------------|----------|----------|-----------|----------|----------|----------|
| Non-Padlockable Handle Block                    | Field Fitted   | 1294C01H01           | EFHB     | –        | LKD3      | LKD4     | LKD4     | –        |
| Padlockable Handle Block                        | Field Fitted   | –                    | –        | –        | –         | –        | –        | –        |
|   | Field Fitted   | 223C77G03            | EFPHB0FF | FJPHB0FF | PHB3      | –        | –        | HLK6     |
| Padlockable Handle Lock Hasp                    | Field Fitted   | –                    | EFPHL0FF | FJPHL0FF | PLK3      | HLK4     | PLK5     | –        |
| Cylinder Lock                                   | Factory Fitted | Order by Description |          |          |           |          |          |          |
| Key Interlock Kit (Provision Only)              | Field Fitted   | –                    | –        | KYKFJ    | KYK3      | KYK4     | KYK4     | KYK6     |
| Slide Bar Interlock – Requires 2 Breakers       | Field Fitted   | –                    | –        | –        | SBK3      | SBK4     | SBK5     | –        |
| Walking Beam Interlock – Requires 2 Breakers    | Factory Fitted | Order by Description |          |          |           |          |          |          |
| Electrical Operator                             | 120 VAC        | –                    | –        | –        | E0P3T07   | E0P4T07  | E0P5T07  | E0P6T08  |
|   | 240 VAC        | –                    | –        | –        | E0P3T11   | E0P4T11  | E0P5T11  | E0P6T11  |
|   | 120 VDC        | –                    | –        | –        | E0P3T07DC | E0P4T26  | –        | –        |
|   | 240 VDC        | –                    | –        | –        | E0P3T11DC | –        | –        | –        |
|   | 24 VDC         | –                    | –        | –        | MOP3PO3DC | E0P4MT21 | E0P5T21K | E0P6T19K |
|   | 48 VDC         | –                    | –        | –        | –         | –        | E0P5T22  | E0P6T21  |
|   | 125 VDC        | –                    | –        | –        | –         | E0P4T21  | E0P5T26  | –        |
| Plug-In Adapters <sup>②</sup>                   | Field Fitted   | –                    | ✓        | ✓        | ✓         | ✓        | ✓        | –        |
| Rear Connecting Studs <sup>②</sup>              | Field Fitted   | –                    | ✓        | ✓        | ✓         | ✓        | ✓        | –        |
| Handle Mechanism Field Fitted Only <sup>②</sup> | Flex Shaft     | ✓                    | ✓        | ✓        | ✓         | ✓        | ✓        | ✓        |
|   | Type SM        | –                    | –        | –        | ✓         | ✓        | –        | –        |
|   | Rotary         | ✓                    | ✓        | ✓        | ✓         | ✓        | ✓        | –        |
|   | Type MC        | –                    | –        | –        | ✓         | ✓        | –        | –        |
|   | Slide Plate    | –                    | –        | –        | ✓         | ✓        | ✓        | ✓        |
|   | Direct         | ✓                    | ✓        | ✓        | ✓         | ✓        | ✓        | ✓        |

**Test Kit**





|  |   |   |   |      |      |      |      |
|--|---|---|---|------|------|------|------|
| Electronic Portable Test Kit (Digitrip 310 Only) | – | – | – | STK2 | STK2 | STK2 | STK2 |
|--|---|---|---|------|------|------|------|

① K-, L-, N- and R-Frame breakers equipped with electronic trip units can operate reliably in ambient temperatures of 50°C.

② Contact Cutler-Hammer for catalogue numbers.

## Cutler-Hammer Frame Sizes G through R

## Selection Guide and Ordering Information

| Accessory  | Pole Location  | Frame |                  |            |           |           |           |           |
|--|----------------|-------|------------------|------------|-----------|-----------|-----------|-----------|
|  |                | G     | E125 and J250    | K          | L         | N         | R         |           |
| <b>Field Fit Kit Catalogue Numbers</b>   |                |       |                  |            |           |           |           |           |
| Alarm Lockout<br>                                       | Make/Break     | Left  | –                | –          | A1L3LPK   | A1L4LPK   | A1L5LPK   | –         |
|  |                | Right | Factory Fit Only | ALM1M1BEPK | A1L3RPK   | A1L4RPK   | A1L5RPK   | A1L6RPK   |
|  | 2 Make/2 Break | Left  | –                | –          | A2L3LPK   | A2L4LPK   | A2L5LPK   | –         |
|  |                | Right | –                | ALM2M2BEPK | A2L3RPK   | A2L4RPK   | A2L5RPK   | A2L6RPK   |
| Auxiliary Switch<br>                                    | 1A, 1B         | Left  | –                | –          | A1X3PK    | A1X4PK    | A1X5LPK   | –         |
|  |                | Right | Factory Fit Only | AUX1A1BPK  | A1X3PK    | A1X4PK    | A1X5RPK   | –         |
|  | 2A, 2B         | Left  | –                | –          | A2X3PK    | A2X4PK    | A2X5LPK   | –         |
|  |                | Right | Factory Fit Only | AUX2A2BPK  | A2X3PK    | A2X4PK    | A2X5RPK   | A2X6RPK   |
|  | 3A, 3B         | Left  | –                | –          | A3X3LPK   | A3X4PK    | A3X5LPK   | –         |
|  |                | Right | –                | –          | A3X3RPK   | A3X4PK    | A3X5RPK   | –         |
| Auxiliary Switch/<br>Alarm Lockout   | Left           | –     | –                | AAL3LPK    | AA114LPK  | AA115LPK  | –         |           |
|  | Right          | –     | AUXALRMEPK       | AAL3RPK    | AA114RPK  | AA115RPK  | –         |           |
| Shunt Trip –<br>Standard <sup>①</sup><br>               | 120 VAC        | Left  | Factory Fit Only | SNT120CPK  | SNT3P11K  | SNT4LP11K | SNT5LP11K | –         |
|  |                | Right | –                | –          | SNT3P11K  | SNT4RP11K | –         | SNT6P11K  |
|  | 240 VAC        | Left  | Factory Fit Only | SNT480APK  | SNT3P11K  | SNT4LP11K | SNT5LP11K | –         |
|  |                | Right | –                | –          | SNT3P11K  | SNT4RP11K | –         | SNT6P11K  |
|  | 24 VDC         | Left  | Factory Fit Only | SNT060CPK  | SNT3P04K  | SNT4LP03K | SNT5LP03K | –         |
|  |                | Right | –                | –          | SNT3P04K  | SNT4RP03K | –         | SNT6P03K  |
|  | 48 VDC         | Left  | –                | SNT060CPK  | SNT3P06K  | SNT4LP23K | SNT5LP23K | –         |
|  |                | Right | –                | –          | SNT3P06K  | SNT4RP23K | –         | SNT6P23K  |
| Shunt Trip –<br>Low Energy   | Left           | –     | –                | LST3LPK    | LST4LPK   | LST5LPK   | –         |           |
|  | Right          | –     | –                | LST3RPK    | LST4RPK   | –         | LST6RPK   |           |
| Undervoltage<br>Release<br>Mechanism <sup>①</sup><br> | 120 VAC        | Left  | Factory Fit Only | UVR120APK  | UVH3LP08K | UVH4LP08K | UVH5LP08K | –         |
|  |                | Right | –                | –          | UVH3RP08K | UVH4RP08K | –         | UVH6RP08K |
|  | 240 VAC        | Left  | Factory Fit Only | UVR480APK  | UVH3LP11K | UVH4LP11K | UVH5LP11K | –         |
|  |                | Right | –                | –          | UVH3RP11K | UVH4RP11R | –         | UVH6RP11K |
|  | 24 VDC         | Left  | –                | UVR024CPK  | UVH3LP21K | UVH4LP21K | UVH5LP21K | –         |
|  |                | Right | –                | –          | UVH3RP21K | UVH4RP21K | –         | UVH6RP21K |
|  | 48 VDC         | Left  | –                | UVR048DPK  | UVH3LP23K | UVH4LP23K | UVH5LP23K | –         |
|  |                | Right | –                | –          | UVH3RP23K | UVH4RP23K | –         | UVH6RP23K |

① Shunt trip and undervoltage release can only be mounted in left pole of K- and L-Frame breakers equipped with electronic trip units.



Handle Mechanisms

Selection Guide and Ordering Information

Handle Mechanisms Overview

Handle Mechanisms are used to operate moulded case circuit breakers, moulded case switches and motor circuit protectors. They are available in three basic configurations — Flange Mounted, Through-the-Door and Direct (Close-Coupled) — providing safe, dependable operation and ease of installation.

Flange Mounted

- Flex Shaft

Through-the-Door

- Universal Rotary

Direct (Close-Coupled)

- Universal Direct
- Euro IEC
- G Direct

Handle mechanisms are typically used on enclosed circuit breakers, control panels and motor control centres in many different applications. Cutler-Hammer has a handle mechanism for virtually any need.

Flange Mounted Handle Mechanisms

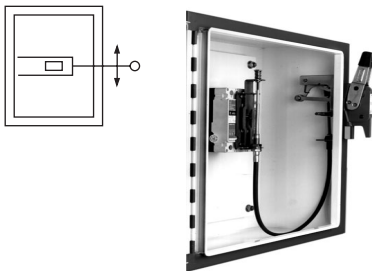

Flex Shaft™

Flange Mounted Handle Mechanisms mount on the flange of an enclosure door. The Flex Shaft™ is an extra heavy-duty mechanism that includes a flexible shaft in various lengths, 0.9 meters (3 feet) through 3 meters (10 feet) for use with various size enclosures.

The Flex Shaft Handle will accept up to three padlock shackles, each with a maximum diameter of 9.5 mm (3/8-inch). Can be used with NEMA 1, 3R and 12 fabricated enclosures. An optional handle is available for Flex Shaft that is suitable for use with NEMA 4 and 4X environments.

Flex Shaft comes preset from the factory, requiring only minor field adjustments on installation, which takes about 10 minutes — a significant time savings compared to installation of other types of flange handle mechanisms. The Flex Shaft mechanism also takes up less interior enclosure space than competitive

designs and the handle fits standard flange cutouts. Flex Shaft handle can be remotely mounted from breaker, where an operator can use it by “funneling” the cable through conduit.

Flex Shaft is UL Listed under File E64893 and meets CSA requirements.

Flex Shaft Ordering Information

| Breaker Frame       | Flexible Shaft Length Meters (Feet) |                               |                               |                               |                      |                      |                    |                         |
|---------------------|-------------------------------------|-------------------------------|-------------------------------|-------------------------------|----------------------|----------------------|--------------------|-------------------------|
|                     | Catalogue Number                    |                               |                               |                               |                      |                      |                    |                         |
|                     | 0.91m (3)                           | 1.22m (4)                     | 1.25m (5)                     | 1.83m (6)                     | 2.13m (7)            | 2.44m (8)            | 2.74m (9)          | 3.05m (10)              |
| EF<br>FJ            | EHMFS03I<br>JHMFS03I                | EHMFS04I<br>JHMFS04I          | EHMFS05I<br>JHMFS05I          | EHMFS06I<br>JHMFS06I          | EHMFS07I<br>JHMFS07I | EHMFS08I<br>JHMFS08I | EHMFS09<br>JHMFS09 | EHMFS10<br>JHMFS10      |
| G<br>K              | F0S03CI<br>F3S03CI                  | F0S04CI<br>F3S04CI            | F0S05CI<br>F3S05CI            | F0S06CI<br>F3S06CI            | F0S07CI<br>F3S07CI   | F0S08CI<br>F3S08CI   | F0S09C<br>F3S09C   | F0S10C<br>F3S10C        |
| L and MDL<br>N<br>R | N/A<br>N/A<br>N/A                   | F4S04CI<br>F5S04CI<br>F6S04CI | F4S05CI<br>F5S05CI<br>F6S05CI | F4S06CI<br>F5S06CI<br>F6S06CI | N/A<br>N/A<br>N/A    | N/A<br>N/A<br>N/A    | N/A<br>N/A<br>N/A  | F4S10C<br>F5S10C<br>N/A |

**Note:** Type 4/4X handle mechanisms are available. Add Suffix X before the I to complete Catalogue Number.

Add Suffix L to complete Catalogue Number for 152.4 mm (6-inch) handle.

Original narrow handle design (No C Suffix) is available. Remove C from Catalogue Number.

**Note:** When selecting the length of shaft, ensure minimum bending radius of 101.6 mm (4 inches) is maintained to operate properly.

The standard method of shipment includes the mechanism preset at the factory; however, minor field adjustments may be required.

Flex Shaft Accessories (E- through R-Frame)

Standard Door Hardware (Required Adapter Kit)

| Latch   | Panel Height mm (Inches) | Catalogue Number |
|---------|--------------------------|------------------|
| 2 point | Up to 762 (30)           | DH1R             |
| 2 point | Up to 1016 (40)          | DH2R             |
| 3 point | Over 1016 (40)           | DH3R             |

Door Hardware Adapter Kit (Required on Standard Door Hardware)

|                           |
|---------------------------|
| Catalogue Number — AMTDHA |
|---------------------------|

Flex Shaft Replacement Door Hardware Kits

| Breaker Frame | Flexible Shaft                         | Catalogue Number       |
|---------------|--|------------------------|
| F<br>J        | 5108A56G01<br>5108A56G02               | LONR<br>LH/RH          |
| F<br>J<br>K   | 5108A56G15<br>5108A56G16<br>5108A56G17 | LONR<br>LH/RH<br>LH/RH |
| F<br>J<br>K   | 5108A56G18<br>5108A56G19<br>5108A56G20 | LONR<br>LH/RH<br>LH/RH |

Door Hardware for Hoffman A – 25 Enclosure<sup>①</sup>

| Latch   | Panel Height mm (Inches) | Catalogue Number |
|---------|--------------------------|------------------|
| 2 point | Up to 1016 (40)          | HDH-2R           |
| 3 point | Over 1016 (40)           | HDH-3R           |

Flange Mounted Instruction Leaflets

| Breaker Frame     | Instruction Leaflet/FRED Number |
|-------------------|---------------------------------|
| EF<br>FJ<br>G     | 29C265<br>29C518<br>TBD         |
| F<br>J<br>K       | 15609<br>15605<br>15604         |
| L and M<br>N<br>R | 15606<br>15606<br>15606         |

<sup>①</sup> Kit consists of special door hardware and door interlock pin. Available for right hand flange mounting only.

## Handle Mechanisms

### Selection Guide and Ordering Information

#### Through-the-Door Handle Mechanisms

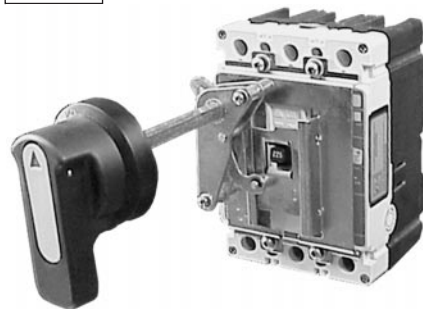
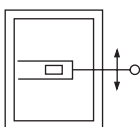

**Rotary**

The Cutler-Hammer Rotary is suitable for use with NEMA 1 and 12 enclosure types. All Rotary handle mechanisms include a handle "Lock Off," to prevent turning the breaker ON while in the OFF position. All Rotary handles indicate ON/OFF/ Tripped/Reset positions, however, Universal Rotary has the added feature of international markings for ON (I) and OFF (O). Cutler-Hammer Rotary handle is metal, Universal Rotary is made of moulded material. Cutler-Hammer Rotary handle is black and Universal Rotary is available in black or yellow/red.

#### Universal Rotary Ordering Information

| Shaft Length<br>in mm (Inches) | Handle<br>Colour | Complete<br>Catalogue Number <sup>①</sup> | Cutler-Hammer Rotary<br>Complete Catalogue Number <sup>①</sup> |          |
|--------------------------------|------------------|---|--|----------|
|                                |                  |   | IEC IP65   | IEC IP66 |
| <b>EF-Frame</b>                |                  |   |  |          |
| 152.4 (6)                      | Black            | EHMVD06B                                  | —  | —        |
| 304.8 (12)                     | Black            | EHMVD12B                                  | —  | —        |
| 152.4 (6)                      | Red              | EHMVD06R                                  | —  | —        |
| 304.8 (12)                     | Red              | EHMVD12R                                  | —  | —        |
| <b>FJ-Frame</b>                |                  |   |  |          |
| 152.4 (6)                      | Black            | FJHMVD06B                                 | —  | —        |
| 304.8 (12)                     | Black            | FJHMVD12B                                 | —  | —        |
| 152.4 (6)                      | Red              | FJHMVD06R                                 | —  | —        |
| 304.8 (12)                     | Red              | FJHMVD12R                                 | —  | —        |
| <b>G-Frame</b>                 |                  |   |  |          |
| 152.4 (6)                      | Black            | GHMVD06B                                  | —  | —        |
| 304.8 (12)                     | Black            | GHMVD12B                                  | —  | —        |
| 152.4 (6)                      | Red              | GHMVD06R                                  | —  | —        |
| 304.8 (12)                     | Red              | GHMVD12R                                  | —  | —        |
| <b>F-Frame</b>                 |                  |   |  |          |
| 152.4 (6)                      | Black            | FHMVD06B                                  | WHM1B06  | WHM1B06X |
| 304.8 (12)                     | Black            | FHMVD12B                                  | WHM1B12  | WHM1B12X |
| 152.4 (6)                      | Red              | FHMVD06R                                  | WHM1R06  | WHM1R06X |
| 304.8 (12)                     | Red              | FHMVD12R                                  | WHM1R12  | WHM1R12X |
| <b>J-Frame</b>                 |                  |   |  |          |
| 152.4 (6)                      | Black            | JHMVD06B                                  | WHM2B06  | WHM2B06X |
| 304.8 (12)                     | Black            | JHMVD12B                                  | WHM2B12  | WHM2B12X |
| 152.4 (6)                      | Red              | JHMVD06R                                  | WHM2R06  | WHM2R06X |
| 304.8 (12)                     | Red              | JHMVD12R                                  | WHM2R12  | WHM2R12X |
| <b>K-Frame</b>                 |                  |   |  |          |
| 152.4 (6)                      | Black            | KHMVD06B                                  | WHM3B06  | WHM3B06X |
| 304.8 (12)                     | Black            | KHMVD12B                                  | WHM3B12  | WHM3B12X |
| 152.4 (6)                      | Red              | KHMVD06R                                  | WHM3R06  | WHM3R06X |
| 304.8 (12)                     | Red              | KHMVD12R                                  | WHM3R12  | WHM3R12X |
| <b>L- and MDL-Frames</b>       |                  |   |  |          |
| 152.4 (6)                      | Black            | LHMVD06B                                  | WHM4B06  | WHM4B06X |
| 304.8 (12)                     | Black            | LHMVD12B                                  | WHM4B12  | WHM4B12X |
| 152.4 (6)                      | Red              | LHMVD06R                                  | WHM4R06  | WHM4R06X |
| 304.8 (12)                     | Red              | LHMVD12R                                  | WHM4R12  | WHM4R12X |
| <b>N-Frame</b>                 |                  |   |  |          |
| 152.4 (6)                      | Black            | HMVD15HB + HMCC5W                         | WHM5B06  | WHM5B06X |
| 304.8 (12)                     | Red              | HMVD15HR + HMCC5W                         | WHM5R12  | WHM5R12X |
| <b>R-Frame</b>                 |                  |   |  |          |
| 152.4 (6)                      | Black            | HMVD15HB + HMCC6W                         | WHM5B06  | WHM5B06X |
| 304.8 (12)                     | Red              | HMVD15HR + HMCC6W                         | WHM5R12  | WHM5R12X |

#### Through-the-Door Instruction Leaflets/ FRED Number

| Breaker<br>Frame | Cutler-Hammer<br>Rotary | Universal<br>Rotary |
|------------------|-------------------------|---------------------|
| EF               | —                       | 29C517              |
| FJ               | —                       | 29C519              |
| G                | —                       | 29C250              |
| F                | 15594                   | 29C250              |
| J                | 15599                   | 29C250              |
| K                | 15600                   | 29C250              |
| L & MDL          | 15601                   | 29C250              |
| N                | 15602                   | —                   |

<sup>①</sup> Complete catalogue number includes handle, mechanism, shaft and mounting hardware.

Handle Mechanisms

Selection Guide and Ordering Information

Direct (Close-Coupled) Handle Mechanisms



Universal Direct



Euro IEC Direct



G Direct

Direct (Close-Coupled) Handle Mechanisms mount directly to the circuit breaker. They are used in shallow enclosures where the standard variable depth Through-the-Door type mechanism is not practical or cannot be used. They are typically for applications where high volume, standardized enclosures are being fabricated.

The Universal Direct handle mechanism is designed exclusively for the new Cutler-Hammer E125 and J250 circuit breakers. It is available as standard with a door interlock to prevent opening the enclosure while the circuit breaker is in the ON position. It is also available without a door interlock.

The Euro IEC Direct handle mechanism can be used on F- through R-Frames.

G Direct is available with a black or yellow handle, and with or without a shroud. It is suitable for use with NEMA 1 enclosures. It is for use only with the G-Frame (GD, GC, GHC, GMCP).

An escutcheon ring and interlock clip are provided as standard. The standard design includes a lock-off feature.

The Universal Direct handle mechanism is UL 489 listed, IEC 60947-1/2 and meets CSA requirements. The Euro IEC Direct handle mechanism is IEC-240-1. G Direct is UL listed and meets CSA requirements.

Universal Direct Ordering Information

| Frame            | Universal Direct Domestic |                           | Universal Direct International                 |
|------------------|---------------------------|---------------------------|--|
|                  | with Interlock (white)    | without Interlock (white) | without Interlock (charcoal with global label) |
| Catalogue Number |                           |                           |  |
| EF               | EHMCCBI                   | EHMCCB                    | EHMCCR   |
| FJ               | JHMCCBI                   | JHMCCB                    | JHMCCR   |

Euro IEC Direct Ordering Information

| Frame   | Catalogue Number |            |
|---------|------------------|------------|
|         | Black Handle     | Red Handle |
| K       | HMCC3B           | HMCC3R     |
| L and M | HMCC4B           | HMCC4R     |
| N       | HMCC5B           | HMCC5R     |
| R       | HMCC6B           | HMCC6R     |

G Direct Ordering Information<sup>①</sup>

| Frame | Catalogue Number |                |               |                |
|-------|------------------|----------------|---------------|----------------|
|       | Black Handle     |                | Yellow Handle |                |
|       | with Shroud      | without Shroud | with Shroud   | without Shroud |
| GD    | HRGCC1S          | HRGCC10        | HRGCC3S       | HRGCC30        |
| GC    | HRGCC1S          | HRGCC10        | HRGCC3S       | HRGCC30        |
| GHC   | HRGCC1S          | HRGCC10        | HRGCC3S       | HRGCC30        |
| GMCP  | HRGMC1S          | HRGMC10        | HRGMC3S       | HRGMC30        |

Direct (Close-Coupled) Instruction Leaflets

| Frame     | Instruction Leaflet/FRED Number |                 |          |
|-----------|---------------------------------|-----------------|----------|
|           | Universal Direct                | Euro IEC Direct | G Direct |
| EF        | 29C255                          | —               | —        |
| FJ        | 29C256                          | —               | —        |
| G         | —                               | —               | 15567    |
| F         | —                               | 29C288A         | —        |
| J         | —                               | 29C288A         | —        |
| K         | —                               | 29C288A         | —        |
| L and MDL | —                               | 29C289          | —        |
| N         | —                               | 29C290          | —        |
| R         | —                               | 29C291          | —        |

<sup>①</sup> Suitable for use on 2- or 3-pole G-Frame.

**Selection Guide and Ordering Information**

**Remote Controlled Operating Mechanisms**

Cutler-Hammer Circuit Breakers (sizes 160 to 2000 amperes) can be equipped with motorized operating mechanisms for remote in-service closing and opening.

For normal remote opening, solenoid operating mechanisms F- and K-Frames are available for circuit breakers and motorized operating mechanisms for J to R (sizes 250 to 2500 amperes) solenoid operating mechanisms and motor operators are always supplied with a locking device for padlocks. This device can be used for electrical and mechanical blocking of the operating mechanism. All remote operating mechanisms are equipped with a manual actuator for local operation.

**Alarm Lockout**

The alarm switches operate when the circuit breaker is tripped by a short circuit or overcurrent, but also when it is tripped by a shunt trip or undervoltage release.

**Auxiliary Switches**

Auxiliary switches are used for signalling and control purposes. The various functions of the auxiliary switches (changeover) are shown in the top table to the right.

**Shunt Trips**

The shunt trip is used for remote tripping.

The coil of the shunt trip is rated only for short-time operation.

It is not permissible with the circuit breaker open to apply a continuous opening command to the shunt trip in order to prevent the breaker from closing.

This means that interlocking circuits with continuous commands may not be set up with shunt trips.

**Possible Equipment of E- and L-Frame Circuit Breakers with Auxiliary and Alarm Switches**

**3-Pole Circuit Breakers** (left and right poles):

|                        |                                       |
|------------------------|---------------------------------------|
| □ / U<sub>C</sub> / DI | 1 AUX                                 |
| □ / U<sub>C</sub> / DI | 2 AUX                                 |
| □ / U<sub>C</sub> / DI | 1 AS                                  |
| □ / U<sub>C</sub> / DI | 1 AS + 1 AUX                          |
| 2 AS                   | 1 AUX                                 |
| 1 AS                   | 2 AUX                                 |
| 2 AS                   | 2 AUX                                 |
| —                      | 4 AUX 4 AUX 4 AUX ●                   |
| —                      | U<sub>C</sub> / 2AS □ / 2AS □ / 2AS ● |

**4-Pole Circuit Breakers** (left and right poles):

|                        |   |                                       |
|------------------------|---|---------------------------------------|
| □ / U<sub>C</sub> / DI | — | 1 AUX                                 |
| □ / U<sub>C</sub> / DI | — | 2 AUX                                 |
| □ / U<sub>C</sub> / DI | — | 1 AS                                  |
| □ / U<sub>C</sub> / DI | — | 1 AS 1 AUX                            |
| 2 AS                   | — | 1 AUX                                 |
| 1 AS                   | — | 2 AUX                                 |
| 2 AS                   | — | 2 AUX                                 |
| —                      | — | 4 AUX 4 AUX 4 AUX ●                   |
| —                      | — | U<sub>C</sub> / 2AS □ / 2AS □ / 2AS ● |

**F-Frame for Motor Protection**

|                        |   |
|------------------------|---|
| □ / U<sub>C</sub> / DI | — |
| 1 AUX                  | — |
| 2 AUX                  | — |
| 1 AS                   | — |
| 1 AS + 1 AUX           | — |
| 2 AS                   | — |

□ / U<sub>C</sub> / DI = Shunt Trip or Undervoltage Release or DI Module (if Built-In)  
 AUX = Auxiliary Switch  
 AS = Alarm Switch  
 ● = For R-Frame Circuit Breakers Only

*E125 and J250 Auxiliary Switch or Alarm Switch in the Right Pole.  
 E125 and J250 Shunt Trip or UVR in the Left Pole.*

**Undervoltage Releases**

The circuit breaker cannot be closed until the undervoltage release is energized. If the release is not energized, the circuit breaker can only perform an idle switching operation.

Frequent idle switching actions should be avoided as they shorten the endurance of the circuit breaker.

**Contact making by the auxiliary and alarm switches as a function of the switching position of the circuit breaker**

| Position of the Toggle Handle Drive (Equivalently Applicable for Rotary Drives) | Position of the Auxiliary Switch | Position of the Alarm Switch |
|---|----------------------------------|------------------------------|
| OFF RESET   |                                  |                              |
| ON  |                                  |                              |
| Tripped   |                                  |                              |

## Time-Current Curves

### Tripping Characteristics

The operating values specified for the inverse time overcurrent releases (thermal overload releases, "a" releases) are mean values of the scatter bands of all setting ranges from the cold state and with uniform current loading of the conducting paths.

The tripping characteristics of the instantaneous (electromagnetic) short circuit releases ("n" releases) are based on the rated phase current  $I_n$  which in the case of circuit breakers with adjustable thermal overload releases is also the upper value of the setting range. With a lower setting current, a correspondingly higher multiple is obtained for the operating current of the "n" release.

Individual time-current curves K- and L-Frame Digitrip 310 Electronic Trip Curves are available upon request.

### Tripping time characteristics (Thermal Memory)

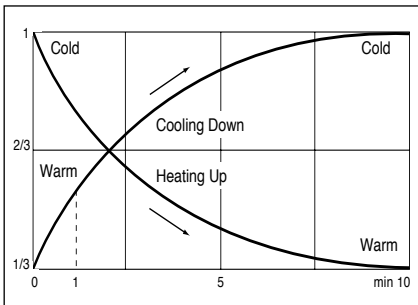

### Type GWF

Tripping characteristics of GWF circuit breakers for plant protection,  $I_{CU} = 25$  kA, "n" release fixed setting  $n = 500-1300$  for breaker 16-63A; 1300-1800 for breaker 70-100A

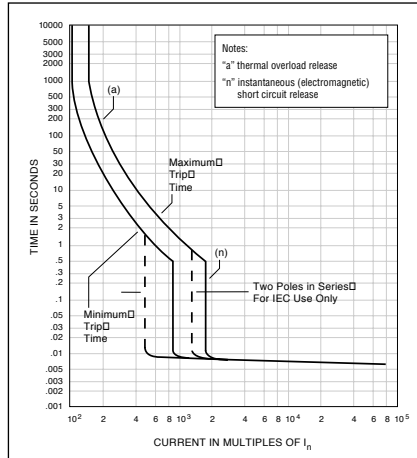

### Type E125

Tripping characteristics of E125 circuit breakers for plant protection,  $I_{CU} = 18/25/40/70$  kA, "n" release fixed setting  $n = 500-1300$  for breaker 16-63A; 1300-1800 for breaker 70-125A

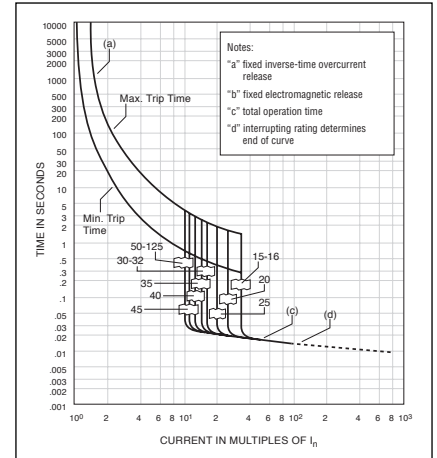

### Type J250

Tripping characteristics of J250 circuit breakers for plant protection,  $I_{CU} = 25/40/70$  kA, "n" release adjustable

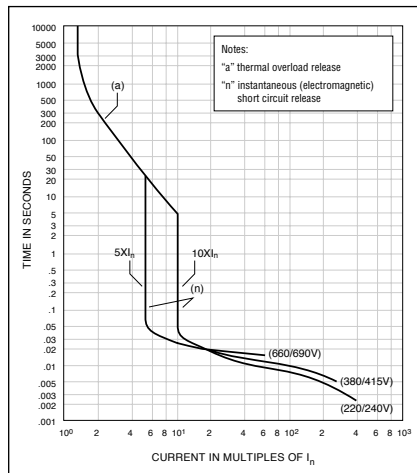

### Type KW

Tripping characteristics of KW circuit breakers for plant protection,  $I_{CU} = 45/70$  kA, "n" release adjustable

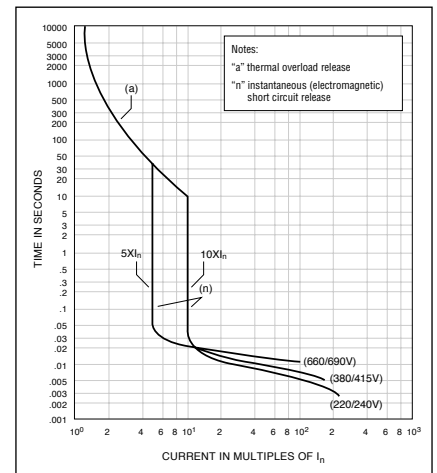

**Cutler-Hammer Frame Sizes K through L**

**Time-Current Curves**

**Tripping Characteristics**

The operating values specified for the inverse time overcurrent releases (thermal overload releases, "a" releases) are mean values of the scatter bands of all setting ranges from the cold state and with uniform current loading of the conducting paths.

The tripping characteristics of the instantaneous (electromagnetic) short circuit releases ("n" releases) are based on the rated phase current  $I_n$  which in the case of circuit breakers with adjustable thermal overload releases is also the upper value of the setting range. With a lower setting current, a correspondingly higher multiple is obtained for the operating current of the "n" release.

**Type KW**

Tripping characteristics of KW circuit breakers for plant protection,  $I_{CU} = 100$  kA, "n" release adjustable

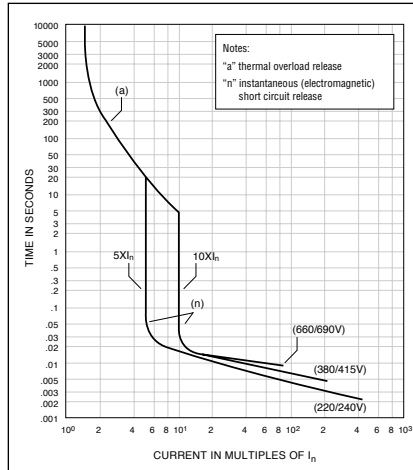

**Type LW**

Tripping characteristics of LW circuit breakers for plant protection,  $I_{CU} = 45/70$  kA, "n" release adjustable

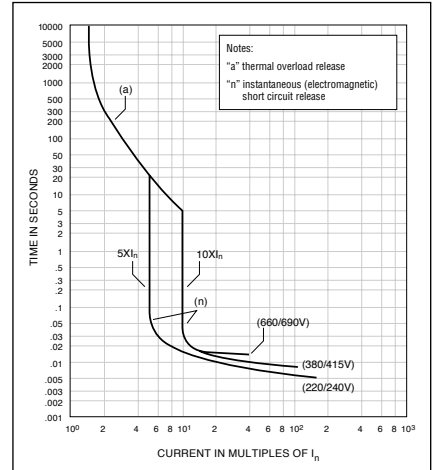

**Type LW**

Tripping characteristics of LW circuit breakers for plant protection,  $I_{CU} = 100$  kA, "n" release adjustable

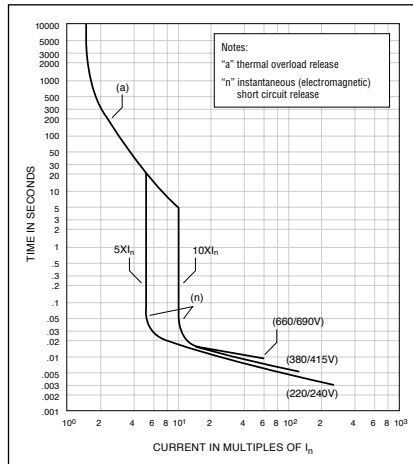

Time-Current Curves

Type NW

Tripping characteristics for NW circuit breakers,  $I_{cu}$  50/70/100 kA, with solid state overcurrent release

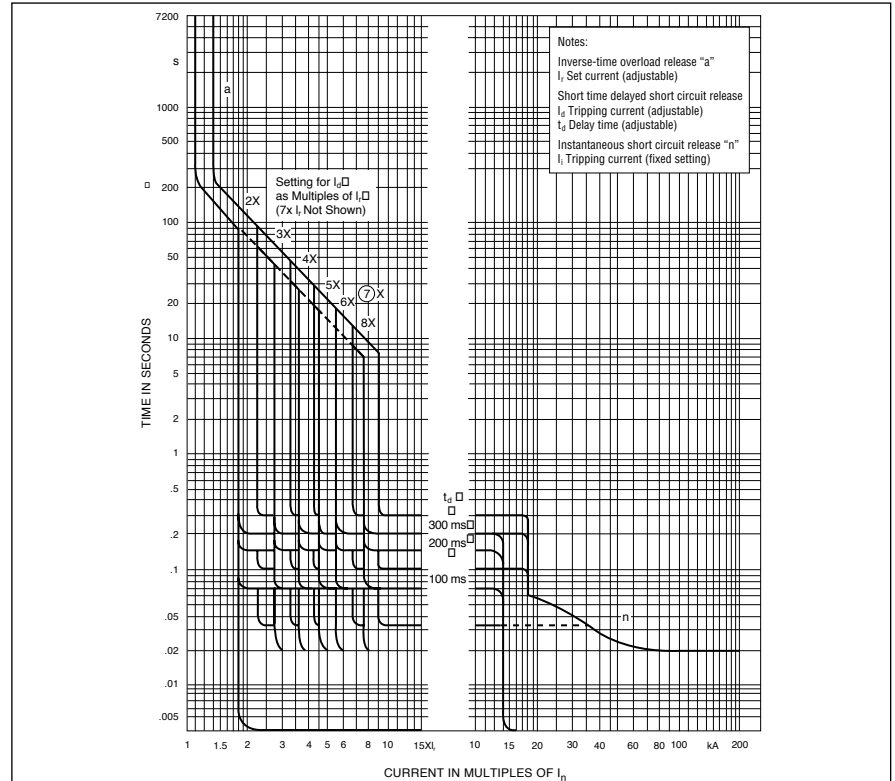

Working Temperature Range

The tolerance bands shown are applicable to an ambient temperature range of -5 to +60°C at the circuit breaker.

Type RW

Tripping characteristics for RW circuit breakers,  $I_{cu}$  70/100 kA, with solid state overcurrent release

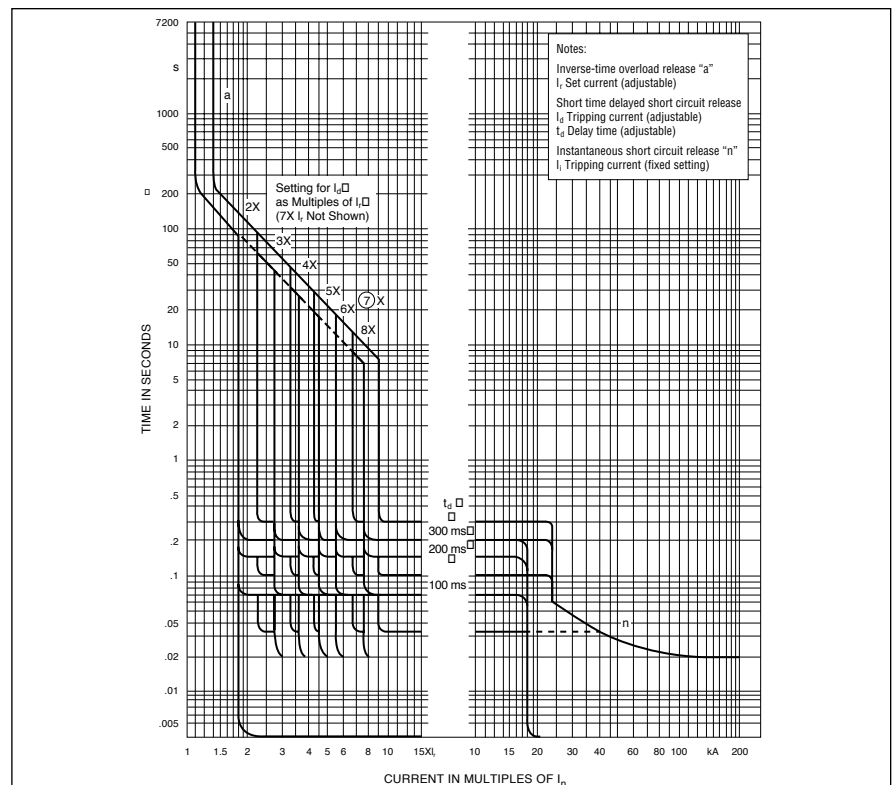

Working Temperature Range

The tolerance bands shown are applicable to an ambient temperature range of -5 to +60°C at the circuit breaker.

Cutler-Hammer Frame Sizes F through L

## Time-Current Curves

### Characteristics of the FWMP, KWMP, and LWMP Circuit Breakers for Motor Protection with Solid State Overcurrent Releases

The tripping times of the inverse-time delayed overcurrent releases are only valid for the not preloaded (cold) state. At operating temperature (after load with rated current), the tripping times are reduced to approximately 33%. After an overcurrent trip, the tripping times are reduced according to the tripping time characteristics (see figure below) so that cooling down for some minutes is required before restarting the motor. During the first minute after tripping, reclosing of the circuit breaker is blocked.

### Type FWMP, KWMP, and LWMP

Tripping characteristics for FWMP, KWMP, and LWMP circuit breakers for motor protection with solid state overcurrent releases

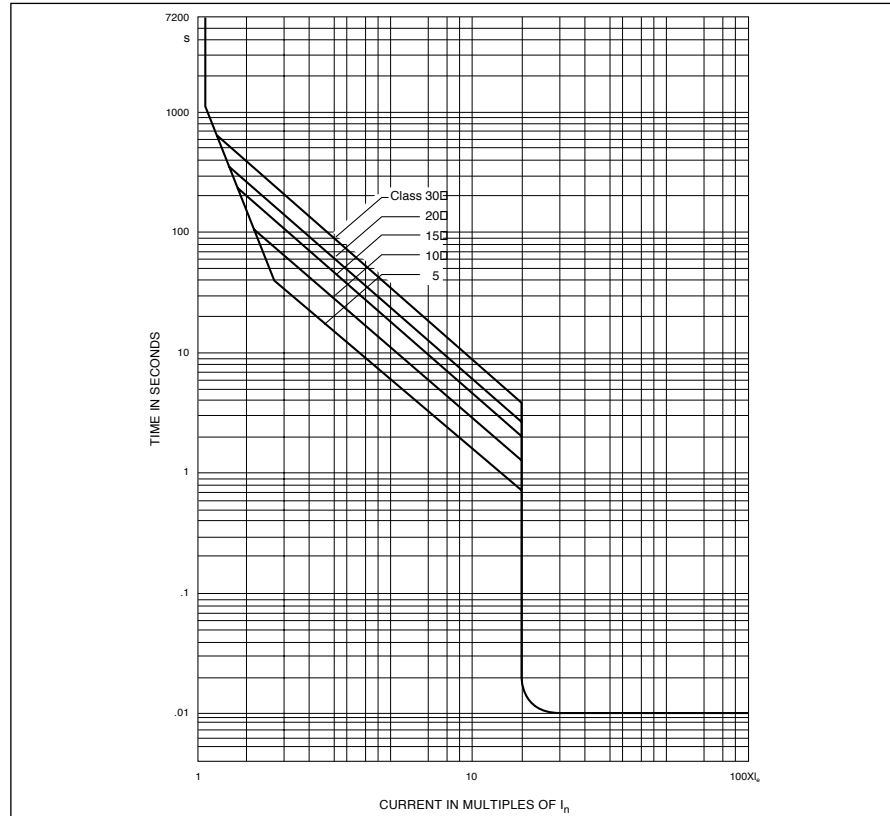



Current Limiting Curves

Current Limiting Characteristics and Maximum I<sup>2</sup>t Values

Type E/LW

Current limiting characteristics for E to LW, 50/60 Hz 380/415 VAC

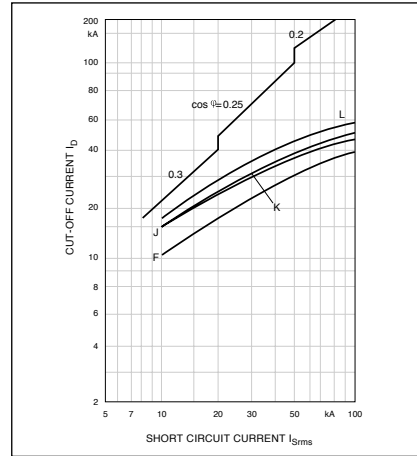

Type E/LW

Current limiting characteristics for E to LW, 50/60 Hz 660/690 VAC

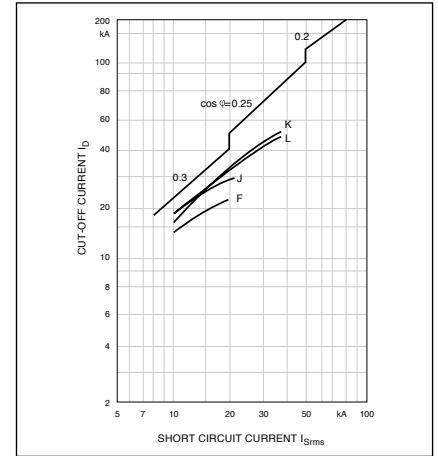

Type NW/RW

Current limiting characteristics for NW to RW, 50/60 Hz 380/415 VAC

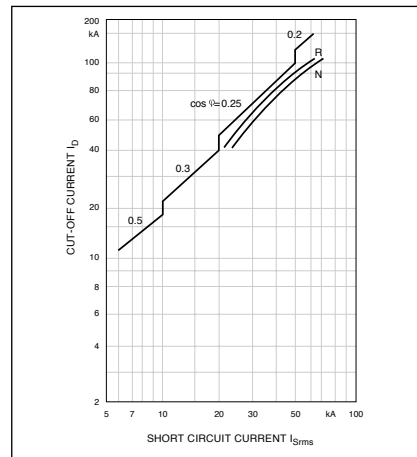

Type FW/LW

Maximum I<sup>2</sup>t values for FW to LW, 50/60 Hz 380/415 VAC

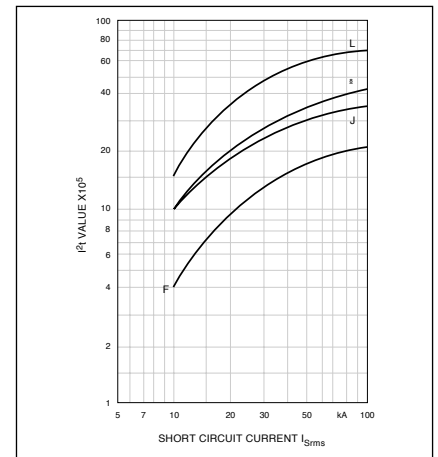

Type FW/LW

Maximum I<sup>2</sup>t values for FW to LW, 50/60 Hz 660/695 VAC

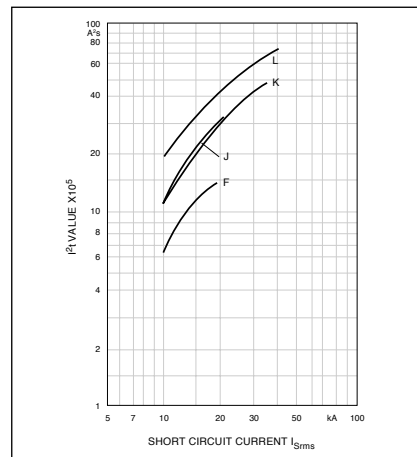

Type NW/RW

Maximum I<sup>2</sup>t values for NW to RW

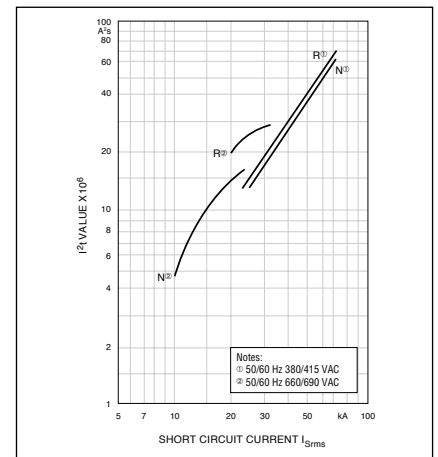

**Cutler-Hammer Frame Sizes G through K**

**Dimensions, mm (inches)**

**G-Frame**

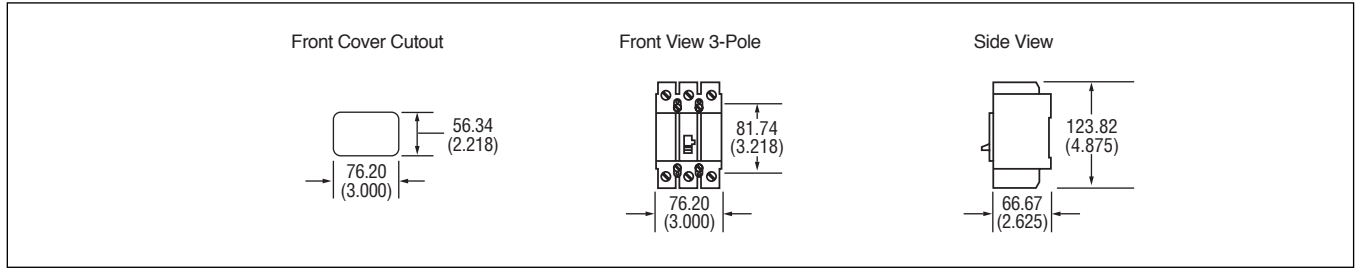

**E125-Frame**

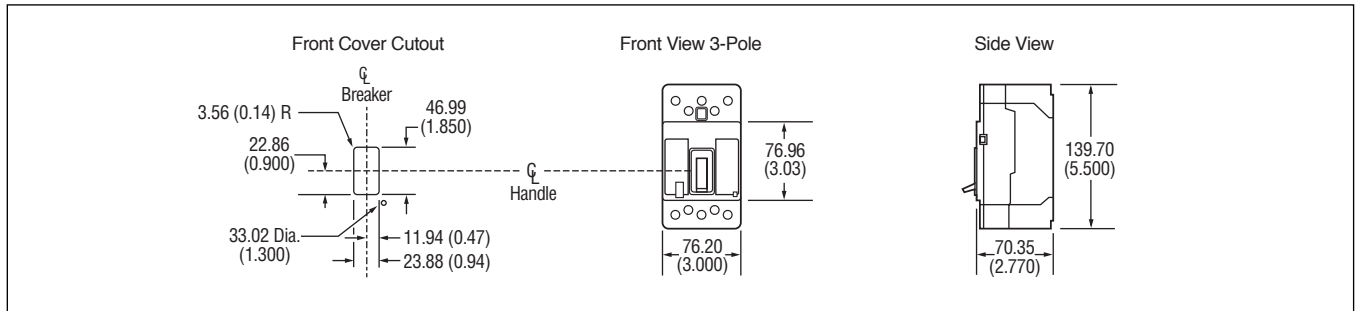

**J250-Frame**

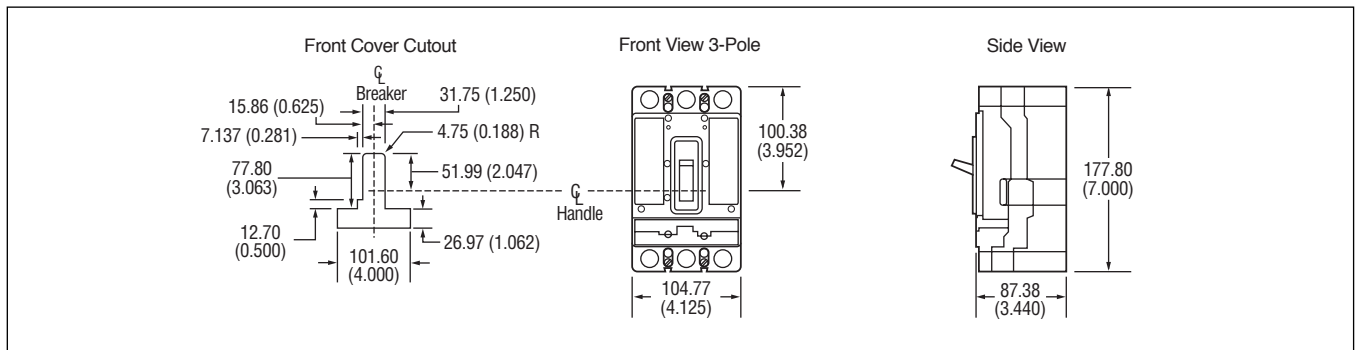

**K-Frame**

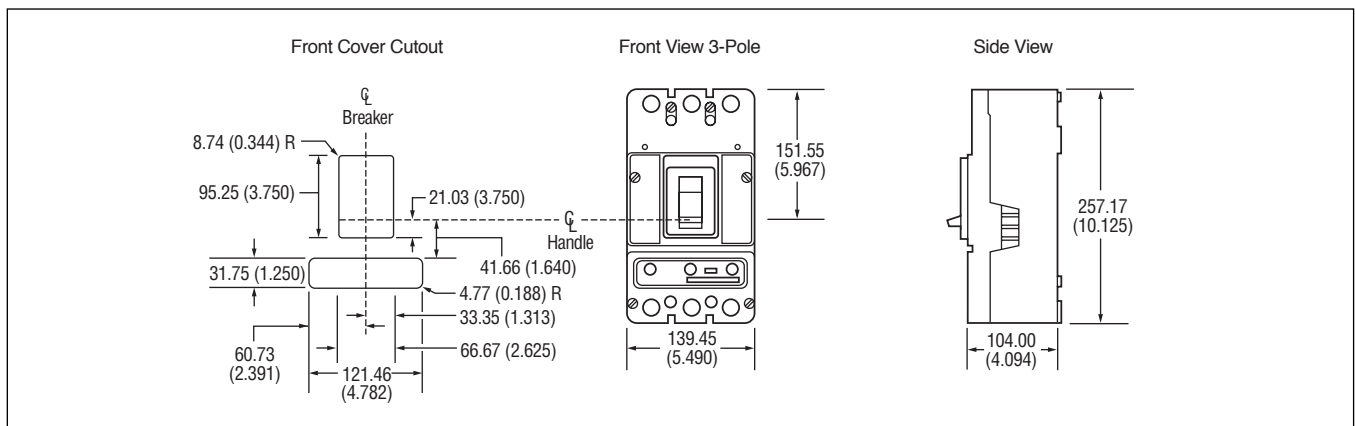

*Dimensions in parentheses in inches.*

Cutler-Hammer Frame Sizes L through R

Dimensions, mm (inches)

L-Frame 630 (Bus extensions not included)  
L-Frame 800

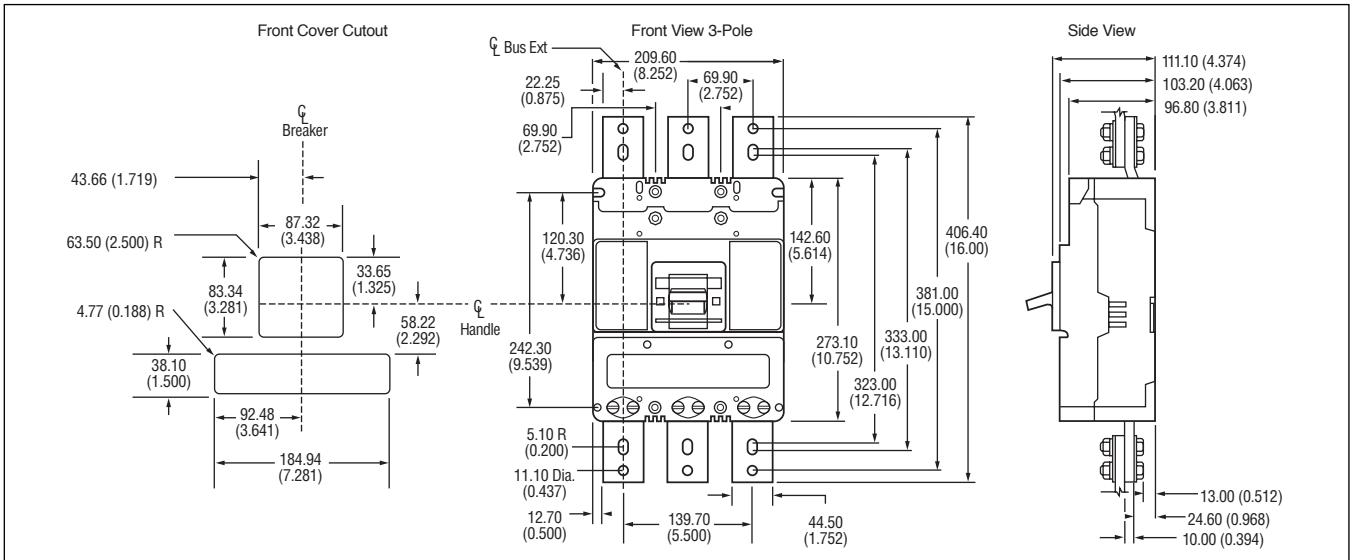

N-Frame

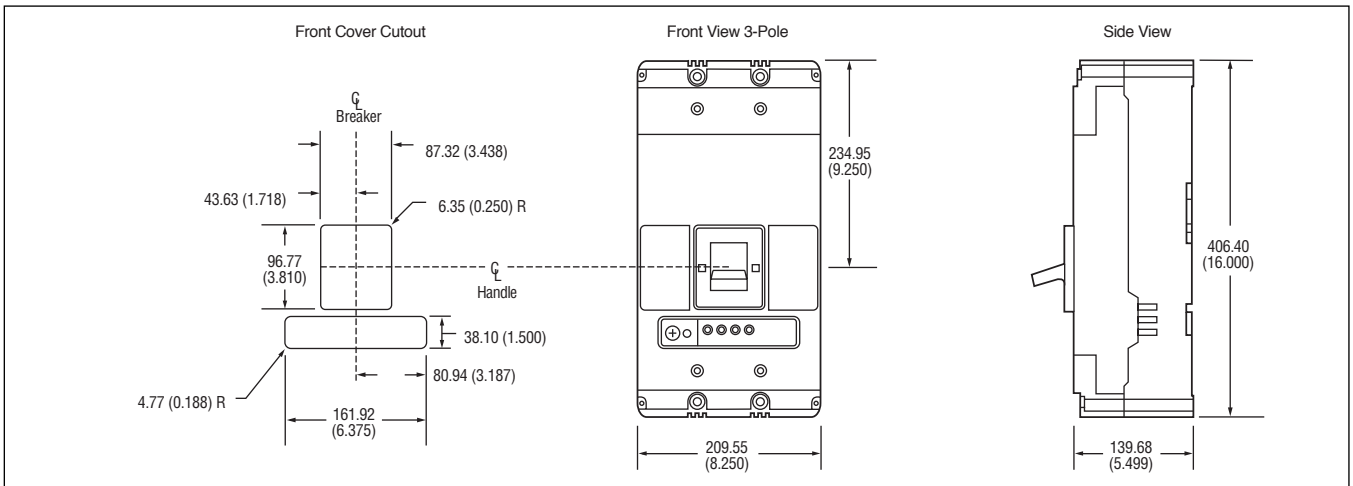

R-Frame

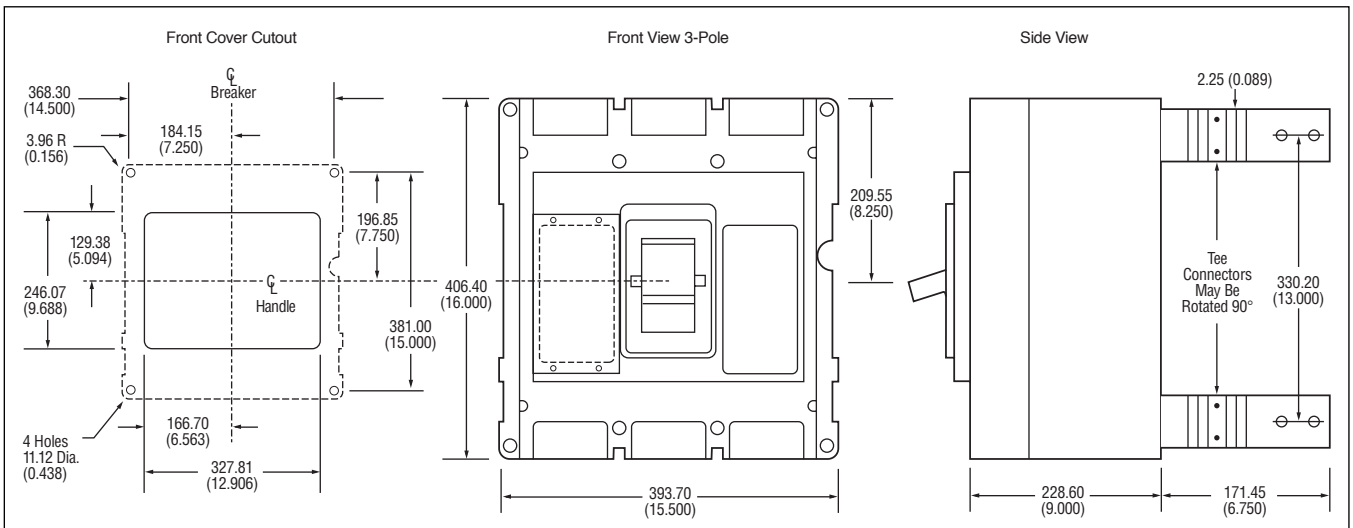

Dimensions in parentheses in inches.

## Cutler-Hammer Sales Offices

### Sales Offices

| Country            | Address  | Office Phone         | Office Fax           |
|--------------------|--|----------------------|----------------------|
| <b>Argentina</b>   |  |                      |                      |
|                    | Cutler-Hammer, Inc.<br>Calle Reconquista 656, Piso 13<br>(1003) Capital Federal – Buenos Aires, Argentina  | (54-11)<br>4315-4066 | (54-11)<br>4314-8946 |
| <b>Australia</b>   |  |                      |                      |
|                    | Cutler Hammer Pty Ltd<br>P.O. Box 85<br>Rosebery, NSW 1445, Australia  | (61-2)<br>9693-9333  | (61-2)<br>9693-1258  |
| <b>Brazil</b>      |  |                      |                      |
|                    | Cutler-Hammer, Inc.<br>Eletromar Plant<br>Estrada Velha da PaPavuna, 257<br>21058-900 Rio de Janeiro-RJ-Brazil   | (55-21)<br>865-3912  | (55-21)<br>290-1645  |
| <b>Canada</b>      |  |                      |                      |
|                    | Cutler-Hammer Canada<br>3228 South Service Road, Box 5040 Station A<br>Burlington, Ontario L7R 3Y8   | (905)<br>333-6442    | (905)<br>631-4248    |
| <b>Chile</b>       |  |                      |                      |
|                    | Cutler-Hammer, Inc.<br>Neveria 4631, Office 210 /203<br>Las Condes CP 6761670<br>Santiago, Chile   | (56-2)<br>207-1695   | (56-2)<br>207-1699   |
| <b>China</b>       |  |                      |                      |
|                    | Cutler-Hammer China<br>193 Su Hong Xi Road, Suzhou Industrial Park<br>Suzhou, 215021, PRC  | (86-512)<br>716-3728 | (86-512)<br>716-9535 |
| <b>Costa Rica</b>  |  |                      |                      |
|                    | Cutler-Hammer, Inc.<br>Industrial Control & Power Distribution<br>Operations-Worldwide Power Distribution Division<br>Apartado Postal 10156<br>1000 San Jose, Costa Rica | (506)<br>235-6022    | (506)<br>235-9156    |
| <b>Egypt</b>       |  |                      |                      |
|                    | Cutler-Hammer, Inc.<br>9, Shehab Street- #11, Mohandessin 12411<br>Cairo, Egypt  | (20-2)<br>338-6170   | (20-2)<br>338-2025   |
| <b>El Salvador</b> |  |                      |                      |
|                    | Cutler-Hammer, Inc.<br>Centro Comercial<br>Villas Españolas, Local C-1<br>San Salvador, El Salvador  | (503)<br>263-6557    | (503)<br>264-4144    |
| <b>France</b>      |  |                      |                      |
|                    | Cutler-Hammer<br>11 Rue Chataigneraie<br>73000 Barberaz, France  | (33-4)<br>79604763   | (33-4)<br>79604766   |
| <b>Germany</b>     |  |                      |                      |
|                    | Eaton GmbH<br>Oranienpassage, 1<br>57258 Freudenberg, Germany  | (49-2734)<br>4663-0  | (49-2734)<br>4760-5  |
| <b>Guatemala</b>   |  |                      |                      |
|                    | Cutler-Hammer, Inc.<br>Avenida Reforma 7-62 zona 9<br>Edificio Aristos Reforma, Oficina N°704<br>Ciudad de Guatemala, Guatemala  | (502)<br>362-9168    | (502)<br>385-0343    |
| <b>Honduras</b>    |  |                      |                      |
|                    | Cutler-Hammer, Inc.<br>Honduras Edificio Miramontes<br>Plaza Apart. Hoteles Continental S.A.<br>Segundo nivel, local N°10<br>Tegucigalpa, Honduras                       | (504)<br>235-7554    | N/A                  |
| <b>Indonesia</b>   |  |                      |                      |
|                    | Cutler-Hammer<br>Suite 503A Sentra Mulia<br>JI HR Rasuna Said Kav X-6 No.8<br>Jakarta 12940, Indonesia   | (62-21)<br>522-2020  | (62-21)<br>522-2110  |

| Country                     | Address  | Office Phone                | Office Fax                   |
|-----------------------------|--|-----------------------------|------------------------------|
| <b>Jordan</b>               |  |                             |                              |
|                             | Cutler-Hammer, Inc.<br>P.O. Box 510449<br>Amman 11151, Jordan  | (962-6)<br>474-0660         | (962-6)<br>744-660           |
| <b>Korea</b>                |  |                             |                              |
|                             | Eaton Limited-Korea<br>7th Floor, Woo Duk Building<br>832-2, Yeoksam-dong, Kangnam-ku<br>Seoul, 135-750, Korea   | (82-2)<br>557-0313          | (82-2)<br>557-1634           |
| <b>Malaysia</b>             |  |                             |                              |
|                             | Eaton Corporation Regional Office<br>c/o Alpha Executive Business Center<br>1005 Blk B Level 10 Phileo Tamansara<br>9 Jin 16/11 Off Jin Tamansara<br>46350 Petaling Jaya, Selangor, Malaysia | (60-3)<br>737-2970          | (60-3)<br>737-2960           |
| <b>Mexico</b>               |  |                             |                              |
|                             | Cutler Hammer, Inc.<br>Rojo Gomez 1300 Col. Sn.Miguel<br>Iztapalapa Mexico City<br>DF 09360 Mexico   | (52-5)<br>804-8230          | (52-5)<br>804-8232           |
| <b>New Zealand</b>          |  |                             |                              |
|                             | Cutler Hammer<br>P.O. Box 12648<br>Penrose, Auckland, New Zealand  | (82-2)<br>557-0313          | (82-2)<br>557-1634           |
| <b>Nicaragua</b>            |  |                             |                              |
|                             | Cutler-Hammer, Inc.<br>Edificio Ofiplaza El Retiro Modulo N°5-1.1<br>De los semaforos de la antrada al antiguo, Nejapa<br>Country Club o CAS 200 m al sur<br>Managua, Nicaragua              | (505)<br>270-0920           | (505)<br>270-0900            |
| <b>Panama</b>               |  |                             |                              |
|                             | Cutler-Hammer, Inc.<br>Avenida Ricardo J. Alfaro<br>Edificio Plaza Edison, Segundo Nivel, Oficina N°7<br>Ciudad de Panama, Panama  | (507)<br>321-0288 /<br>0289 | (507)<br>321-0290            |
| <b>Saudi Arabia</b>         |  |                             |                              |
|                             | Cutler-Hammer, Inc.<br>P.O. Box 19651, Riyadh 11445<br>Kingdom of Saudi Arabia   | (966-1)<br>460-2275         | (966-1)<br>460-2991          |
| <b>Singapore</b>            |  |                             |                              |
|                             | Cutler-Hammer Pte Ltd<br>3 Tai Seng Drive<br>#03-01 Marconi Building<br>Singapore 535216   | (65)<br>382-7330            | (65)<br>382-7262             |
| <b>Thailand</b>             |  |                             |                              |
|                             | Cutler-Hammer (C-H 1254)<br>Eaton Technologies Limited, 91/1 Chailyo Building,<br>5th Floor, Rama 1X Road, Huaykwang<br>Bangkok 10320 Thailand   | (66-2)<br>643-9504-8        | (66-2)<br>643-9509           |
| <b>United Kingdom</b>       |  |                             |                              |
|                             | Cutler-Hammer<br>Carina, Sunrise Parkway<br>Linford Wood<br>Milton Keynes MK146NR  | (44-0-1908)<br>541600       | (44-0-1908)<br>660527        |
| <b>United States</b>        |  |                             |                              |
|                             | Cutler-Hammer, Inc.<br>1000 Cherrington Way<br>Pittsburgh, PA 15108  | (412)<br>893-3300           | N/A                          |
| <b>Venezuela</b>            |  |                             |                              |
|                             | Cutler-Hammer, Inc.<br>Avda. Libertador, El Rosal, Edificio Lex, Piso 1<br>Caracas 1060, Venezuela   | (58-2)<br>953-1697          | (58-2)<br>953-2585 /<br>2841 |
| <b>United Arab Emirates</b> |  |                             |                              |
|                             | Cutler-Hammer Inc.<br>P.O. Box 9398, Dubai World Trade Centre – Level<br>10 Dubai, United Arab Emirates  | (971-4)<br>331-3938         | (971-4)<br>332-9239          |

# Typical Specifications for Cutler-Hammer Moulded Case Circuit Breakers

The circuit breakers shall meet or exceed all standards as defined in IEC 60947-2. Electrical circuits shall be protected by Cutler-Hammer World Moulded Case Circuit Breakers as manufactured by Cutler-Hammer.

Each pole of the one-, two-, and three-pole circuit breakers shall provide complete circuit overcurrent protection by having inverse time and instantaneous tripping characteristics and, where applicable, be current limiting.

The circuit breaker shall be available in interrupting families that provide 35-65-100 kA at 380-415 volts AC.

The circuit breakers shall be operated by a toggle-type handle and have a quick-make, quick-break, over-centre switching mechanism that is mechanically trip-free from the handle so that the contacts cannot be closed against short circuit currents. Tripping due to overload or short circuits shall be clearly indicated by the position of the handle. The ON and OFF positions shall be clearly marked on the cover of the circuit breaker along with the international symbols I for ON and O for OFF on the handle, providing positive indication of the circuit breaker contact position. Additionally, a colour-coded indication of the circuit breaker contact position shall be provided: red for ON, green for OFF, and white for TRIPPED. An easily accessible Push-To-Trip button for mechanically exercising the trip unit shall be provided on the cover of each circuit breaker. All poles of a multi-pole circuit breaker shall be so constructed as to ensure simultaneous open, close, and trip operations.

Circuit breakers shall be completely enclosed in a high strength glass-polyester case.

Noninterchangeable trip circuit breakers shall be factory sealed; interchangeable trip circuit breakers shall have the trip unit sealed to prevent tampering. Ampere ratings shall be clearly visible from the front of the circuit breaker. Contacts shall be nonwelding silver alloy. Arc extinction shall be accomplished by means of DE-ION<sup>®</sup> arc extinguishers consisting of metal grids mounted in an insulating support.

The minimum interrupting ratings of the circuit breakers shall be at least equal to the available short circuit current at the line terminals.

The circuit breakers can be applied in series rated applications and subject to test data verification.

Circuit breakers in frame sizes 125 amperes through 250 amperes shall be equipped with thermal-magnetic trip units. Circuit breakers 400 amperes through 2500 ampere frame sizes shall be equipped with electronic trip units that are insensitive to changes in ambient temperature within the normal operating temperature range of the circuit breaker. The 400 ampere and 630 ampere frame sizes shall be designed to accept either thermal-magnetic or electronic interchangeable trip units.

Electronic trip units shall be rms sensing type and have unpowered thermal memory.

Circuit breaker ratings and modifications shall be indicated on the drawings.

Circuit breakers shall be of the inverse time and instantaneous trip type as provided by thermal-magnetic or electronic trip elements with either standard interrupting, high interrupting, or current limiting characteristics as required.

Moulded case circuit interrupters (motor circuit protectors) shall be of the instantaneous (magnetic) only type, providing instantaneous short circuit protection by means of a front adjustable trip unit.

Moulded case switches shall be of the same construction as the related listed circuit breaker and equipped with a factory sealed, nonadjustable, high instantaneous only short circuit protection.

Moulded case switches shall have no overload or low level fault protection provided and shall be marked with a maximum withstand rating denoting the type and level of upstream protection required. Moulded case switches shall be listed per IEC 60947-2.

Internally mounted accessories including alarm (signal)/lockout switches, auxiliary switches, shunt trips, and undervoltage released mechanisms shall be of the plug-in type and shall be listed for field fitting in circuit breakers which are not factory sealed.

Electrical operators for circuit breakers of the 400 ampere frame size and below shall be of the solenoid type with maximum five-cycle closing characteristics. Electrical operators for circuit breaker frame sizes 630 amperes through 2500 amperes shall be of the motor driven type. All electrical operators shall be cover mounted. All electrical operators shall be listed for field installation per IEC 60947-2.

Electrical characteristics of accessories shall be as indicated on the drawings.

Circuit breakers in the 125 amperes rating shall be supplied in one-, two-, three-, and four-pole models, as specified on the drawings. Circuit breakers in ratings of 225 amperes through 1250 amperes shall be supplied in two-, three-, or four-pole models. The 2500 ampere circuit breaker is available in three- and four-pole models as specified on the drawings.

Accessory wiring shall be brought out through the side or rear of the circuit breaker, or be connected to a terminal block mounted on the side of the circuit breaker, as specified. The ability to route accessory wiring to the opposite side of the circuit breaker through a trough in the base shall be provided.

Circuit breakers shall be provided with uniformly designed nameplates to clearly indicate the type, rating, listing/recognition/certification marks, accessory details, and other information defined in IEC 60947-2.